

Shift Chain

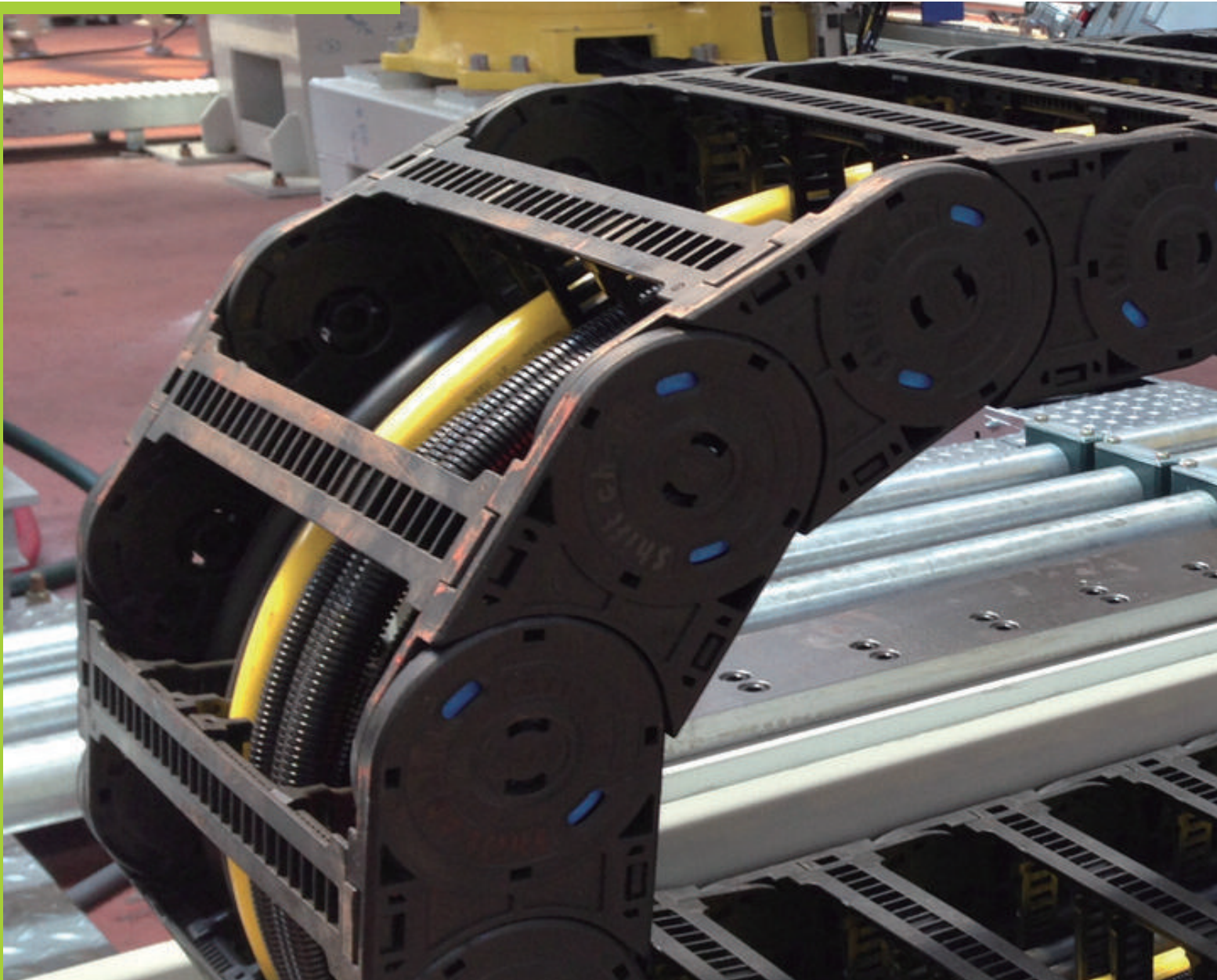

Shift chain®

ST - N : Normal type

▶ST044N	C-9
▶ST055N	C-11
▶ST072N	C-13
▶ST095N	C-15
▶ST120N	C-17
▶ST150N	C-19

ST - E : Enclosed type

▶ST044E	C-27
▶ST055E	C-29
▶ST072E	C-31
▶ST095E	C-33
▶ST120E	C-35
▶ST150E	C-37

ST - S : Skid type

▶ST044S	C-43
---------	------



ST - ES :
Enclosed Skid type

▶ST044ES	C-51
▶ST072ES	C-53
▶ST095ES	C-55
▶ST120ES	C-57

ST - RS :
Roller Skid type

▶ST044RS	C-65
▶ST072RS	C-67
▶ST095RS	C-69
▶ST120RS	C-71
▶ST150RS	C-73

ST - ERS :
Enclosed Roller Skid type

▶ST044ERS	C-81
▶ST072ERS	C-83
▶ST095ERS	C-85
▶ST120ERS	C-87

Shift Chain - Normal type

» General information

Item	Value
Material	CPS-Amid(PA6+GF), RoHs
Speed	3m/s
Acceleration	10m/s²
Temperature	-30°C ~+130°C
Special production	ESD, UV
Certificate	CE, ATEX(Ex)

» Calculation table

Item	Value
Length of Cable Chain	$L = \frac{1}{2} \times LS + LP$
Bending Radius	
The biggest Cable inserted	Multiply 8~10 and the biggest cable
The biggest Hydraulic Hose inserted	Multiply 15~20 and the biggest hose

» Dimension table

Shift Chain N Type	Pitch	Bending Radius (R)	Weight kg/m	Speed m/s	Temperature °C	Size				Frame type	Section-composition
						A	B	C	D		
ST 044N	44	50, 70, 90, 120, 150	0.93	3	-30 ~ +130	56	35	38	26		
			0.97			50					
			1.00			55					
			1.06			75					
			1.17			100					
			1.30			125					
			1.43			150					
			1.78			175					
			1.94			200					
			ST 055N			55	65, 75, 100, 125, 150, 200		1.12		
1.15	50										
1.18	55										
1.23	75										
1.31	100										
1.41	125										
1.51	150										
1.78	175										
1.92	200										
ST 072N	72	72, 100, 120, 145, 200, 250, 300		2.10	3			-30 ~ +130	82	50	66
			2.20	75							
			2.30	100							
			2.43	125							
			2.51	140							
			2.56	150							
			2.62	175							
			2.66	190							
			2.93	200							
			3.11	240							
3.21	250										
3.24	250										
3.60	300										
ST 095N	95	135, 150, 200, 230, 280, 400	3.11	3	-30 ~ +130	113	75	82	56		
			3.17			100					
			3.37			125					
			3.49			150					
			3.60			175					
			3.71			190					
			3.79			200					
			4.00			240					
			4.05			250					
			4.31			300					
4.69	350										
5.05	400										
ST 120N	120	180, 200, 250, 300, 350, 400, 500	4.41	3	-30 ~ +130	117	75	108	78		
			4.53			100					
			4.61			115					
			4.67			125					
			4.78			150					
			4.93			175					
			5.17			200					
			5.41			240					
			5.47			250					
			5.80			290					
5.88	300										
6.30	350										
6.73	400										
7.07	450										
7.30	500										
8.13	550										
8.30	600										
ST 150N	150	205, 305, 405, 505, 605	5.85	3	-30 ~ +130	121	75	140	110		
			5.96			100					
			6.03			115					
			6.08			125					
			6.18			150					
			6.30			175					
			6.51			200					
			6.72			240					
			6.78			250					
			7.06			290					
7.14	300										
7.51	350										
7.88	400										
8.18	450										
8.37	500										
9.11	550										
9.26	600										

(Dimensions in mm)

» Ordering

ST 044N, 100, R120 / F - 1500L : 10ST

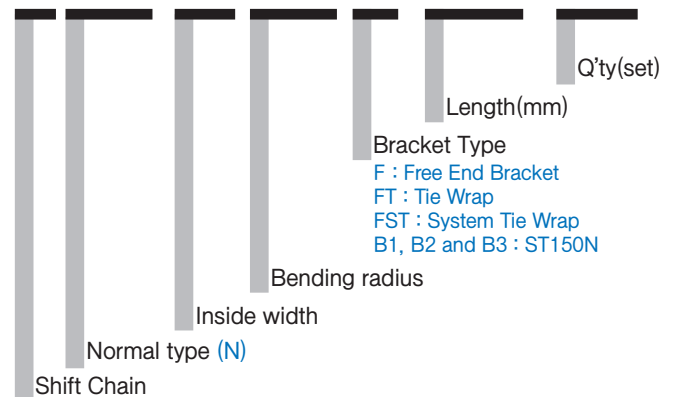

» Bracket type

- ST044, ST055, ST072, ST095, ST120

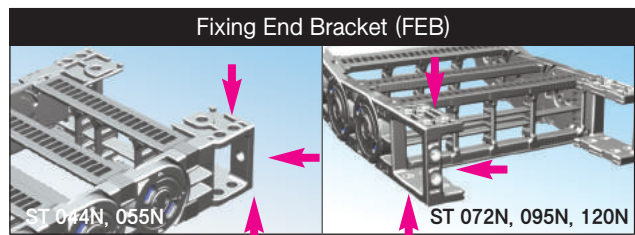

- ST150

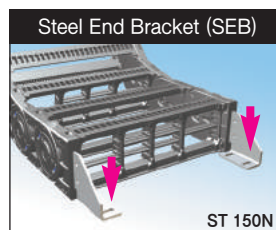

For ST150N, its end parts of cable chain being fixed are used with steel bracket, and it is possible to be installed B1, B2, B3 types of brackets.

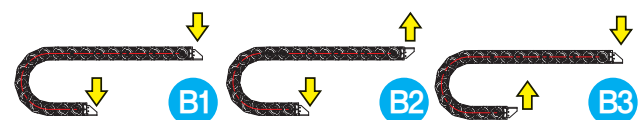

» Application of Shift Chain

- Shift Chain can be applied to all kinds of machine tools and factory lines.



▶ **ST 044N** **Application:**
Machine tool
Location:
Italy
Remark:
Verious stroke and direction



▶ **ST 120N** **Application:**
Robot Carriage line
Location:
China
Remark:
Stroke 3 meters

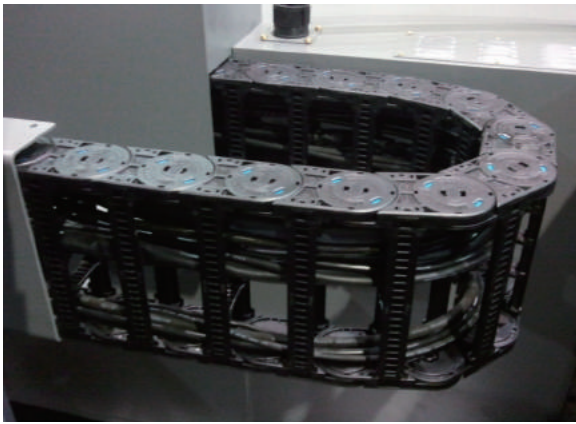

▶ **ST 055N** **Application:**
Machine tool
Location:
Japan
Remark:
Side mounting



▶ **ST 095N**
Application:
Steel manufacturing line
Location:
Korea
Remark:
Verious stroke and direction



▶ **ST 072N**
Application:
Nylon Cloth cutting machine
Location:
Italy
Remark:
Stroke 2,5 meters

» Customized Shift Chain

Shift Chain is designed to be able to move in upper, lower and diagonal directions according to machine's movement. Changing a different Bending Radius value at the point that the chain movement turn other sides can create the bending radius or the reverse bending radius for the direction that you need, so the machine can move in zigzag direction. Shift Chain can be used for special usage such as a zigzag chain, and has an excellent installation scalability in any hazard environment for cable protection with the general chain. If you need special chain installation, please contact our R&D center.

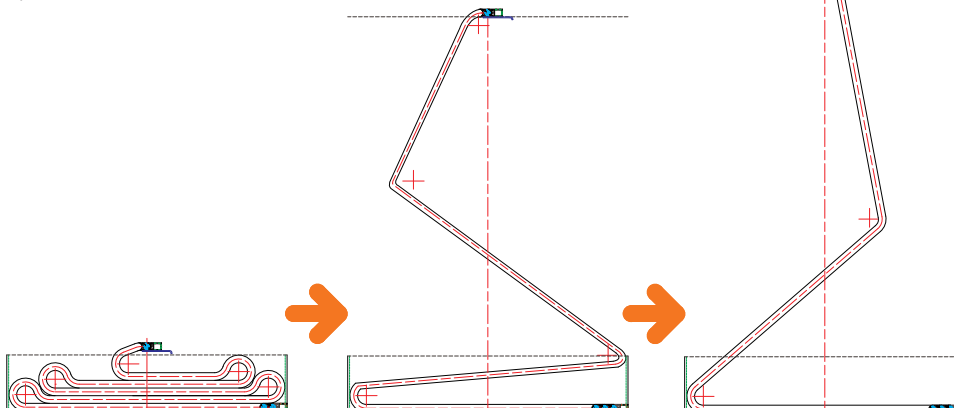

Shift Chain - Normal type

» Part of Shift Chain Normal type

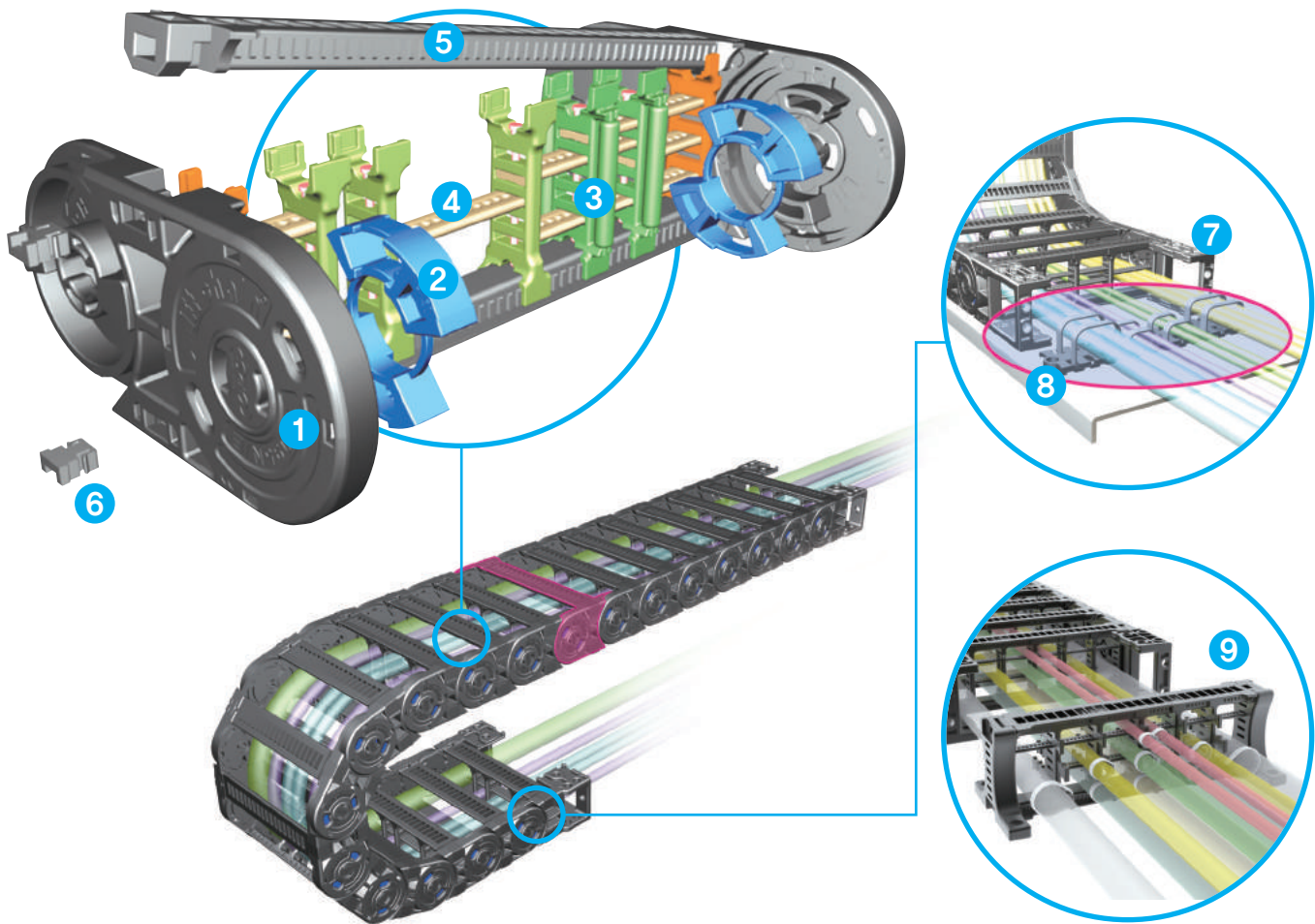

1 Side Band (SB)

A unit that connects each side band and between them BR is inserted to strengthen clamping force.

2 Bending Radius Unit (BR)

A unit that inserted between each side band. There are 6 supporting points to create durability.

3 Divider (DV-S, M, R, T)

A unit that divides inserted cables horizontally.

4 Separator (SP)

A unit that divides inserted cables vertically to prevent twisting and breaking problem.

5 Frame (Hinged Type) (FR)

Hinged-type frame, open one side, supports connection of both side of side band and have tongue and groove system plate to secure the position of the divider on the frame.

6 Frame Pin (FP)

The connecting pin for preventing the breakaway of Frame connected at Side Band, combining and fixing the Frame and Side Band. For Shift chain(ST)072N, 092N, 120N, 150N type, one side of the frame is fixed by inserting a fixing pin to prevent frame open, which caused by any external impact. Also, in case of ST044N, ST055N type, an open side of the frame is fixed by Hook-type frame.

7 Free End Bracket (FEB)

A unit that connects at last side band (left&right). It can be fixed stronger using steel washers.

8 Tie Wrap (TW)

A unit that ties cables to maintain straightness of them. It can be assembled to bracket directly or installed separately from bracket.

9 System Tie Wrap (STW)

System-Tie Wrap has to be assembled on fixing and moving point of bracket and can be assembled without any tie wrap plate. This tie wrap is used to stay the cables on several floors prevent the cables from being twisted and it can also be assemble without any tools or bolt. This tie wrap has two types, one is to assemble inside bracket the other one is outside.

» Assembly procedure of Shift Chain Normal type

The assembling process of Shift Chain N-Type is like below and users must use rubber hammer with careful combination of Divider and Separator. Be careful of different assembling process depending on product specification such as ST044N, 055N Type, ST072N, 095N, 120N Type, ST150N Type etc.

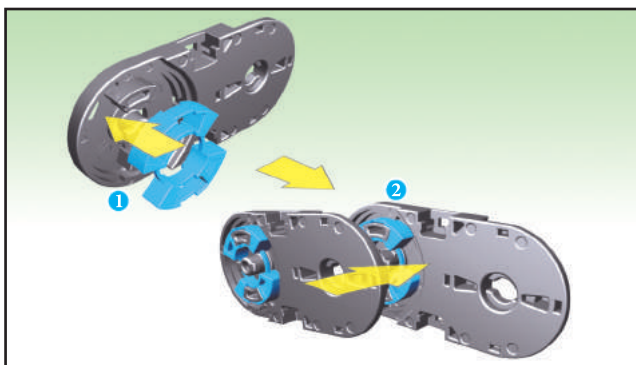

1 Insert BR unit to each side band, connect the side bands as many as you need, then do the same process to the other side of side band.

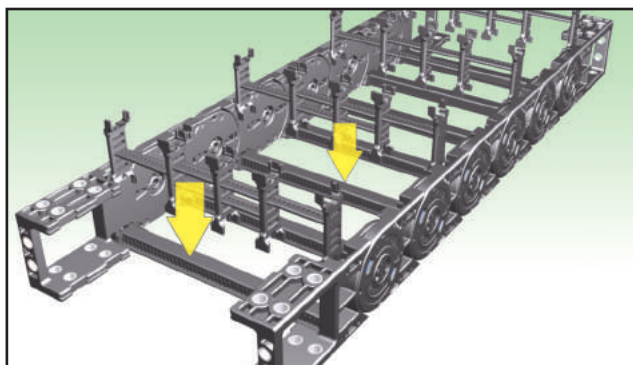

5 Fix the separator and divider patterns to the bottom-side frames as needed.

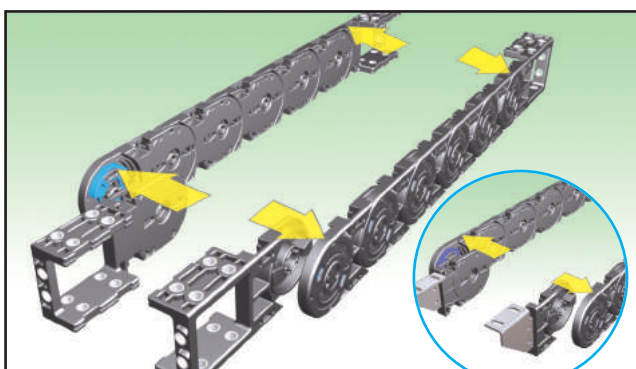

2 Assemble the end brackets on both ends using the same method.

For ST150N, assemble steel brackets on both ends.

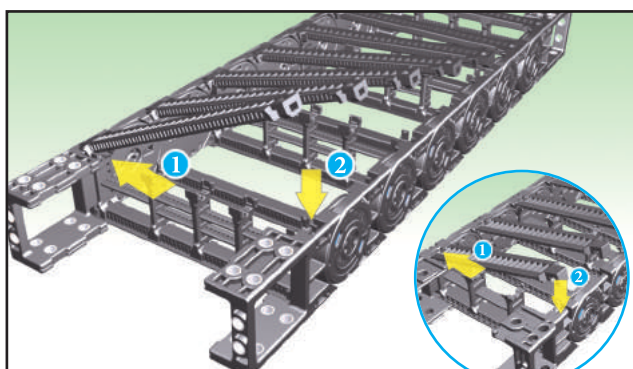

6 Attach frames to one side groove on the side band, and then the other side.

ST044N, 055N frame type.

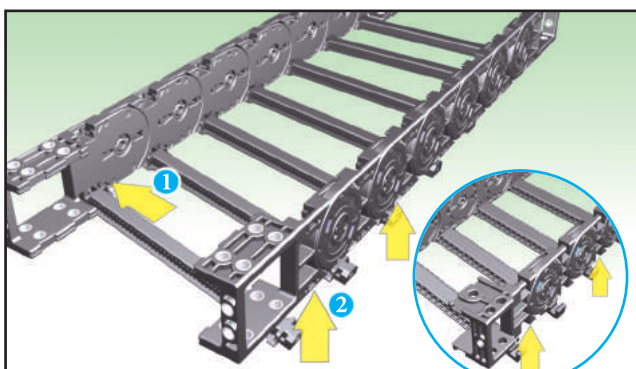

3 Attach frames to one side groove on the side band, and then the other side.

ST 044N, 055N are Hinge Type or Hook Type without frame pin.

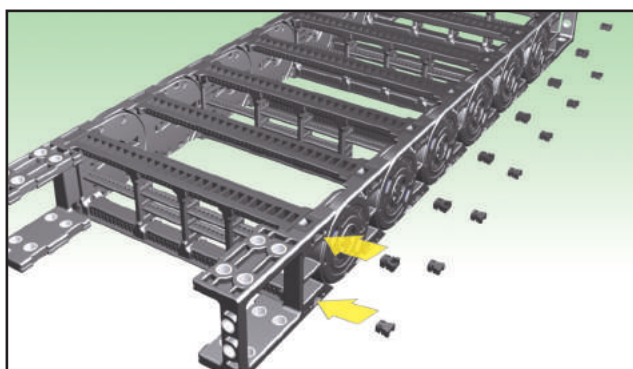

7 Insert frame pins to secure the frames and complete carrier. (ST072N, 095N, 120N, 150N are applied with frame pin, and ST044N, 055N are Hinge Type or Hook Type without frame pin.)

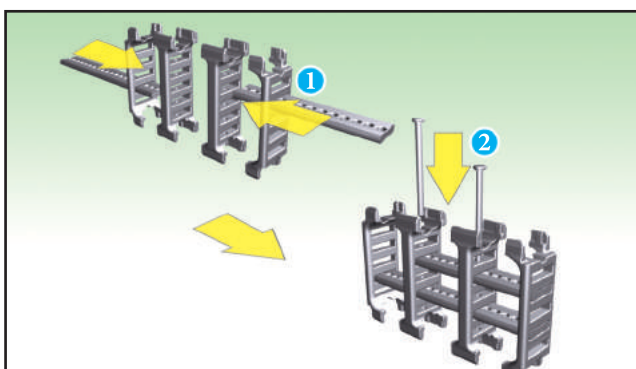

4 For ST072N, 095N, 120N, and 150N, connect the pin of separator in hole of divider after inserting separator in hole of divider. For ST044N and ST055N, separator fixing pins are not used.

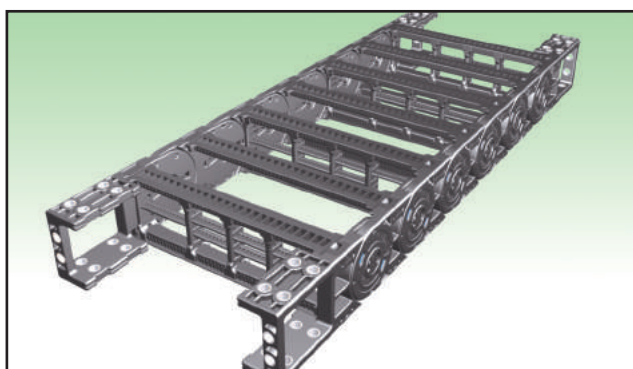

8 Assembled Shift Chain N-Type is assembled.

Shift Chain - Normal type

» Part list of Shift Chain Normal type

- Composition of Cable chain(Standard)
= Side band(RH) + Frame + Side band(LH) + Bending radius Unit + Free end bracket
- M divider(normal divider) should be applied every second frames to make a section composition.
- ※ Please refer to below part list and description to understand composition of cable chain.

Model	Classification	Part number	Description
ST044N	SIDE BAND	ST-SB044N/E(LH) ST-SB044N/E(RH)	Left side band of ST044N Right side band of ST044N
	BENDING RADIUS	ST-BR044.R50,70,90,120,150	Bending radius unit for side band
	FRAME	sb-FR/M,35 sb-FR/M,50 sb-FR/M,55 sb-FR/M,75 sb-FR/M,100 sb-FR/M,125 sb-FR/M,150 sb-FR/M,175 sb-FR/M,200	Frame, 35mm Frame, 50mm Frame, 55mm Frame, 75mm Frame, 100mm Frame, 125mm Frame, 150mm Frame, 175mm Frame, 200mm
	FREE END BRACKET	ST-FEB044N/S	End bracket of ST044N
	DIVIDER	sb-DV028/M sb-DV028/S	Normal divider To fix separstors at the both side section
	SEPARATOR	S-SP/M,35 S-SP/M,50 S-SP/M,75 S-SP/M,100 S-SP/M,125 S-SP/M,150 S-SP/M,175 S-SP/M,200	Separator, 35mm Separator, 50mm Separator, 75mm Separator, 100mm Separator, 125mm Separator, 150mm Separator, 175mm Separator, 200mm
	TIE WRAP	S-TW036/025CR,35 S-TW036/025CR,55 S-TW036/025CR,75 S-TW036/025CR,100 S-TW036/025CR,125	Tie wrap for end bracket to fix cables, 35mm Tie wrap for end bracket to fix cables, 55mm Tie wrap for end bracket to fix cables, 75mm Tie wrap for end bracket to fix cables, 100mm Tie wrap for end bracket to fix cables, 125mm
	SYSTEM TIE WRAP	sb-DV028/W S-TW,EB028	Divider for fixing cables at end bracket System tie wrap to arrange for cables right after moving bracket or fixing bracket

Model	Classification	Part number	Description
ST055N	SIDE BAND	ST-SB055N/E(LH) ST-SB055N/E(RH)	Left side band of ST055N Right side band of ST055N
	BENDING RADIUS	ST-BR055.R65,75,100,125,150,200	Bending radius unit for side band
	FRAME	sb-FR/M,35 sb-FR/M,50 sb-FR/M,55 sb-FR/M,75 sb-FR/M,100 sb-FR/M,125 sb-FR/M,150 sb-FR/M,175 sb-FR/M,200	Frame, 35mm Frame, 50mm Frame, 55mm Frame, 75mm Frame, 100mm Frame, 125mm Frame, 150mm Frame, 175mm Frame, 200mm
	FREE END BRACKET	ST-FEB055N/S	End bracket of ST055N
	DIVIDER	sb-DV035/M sb-DV035/S	Normal divider To fix separstors at the both side section
	SEPARATOR	S-SP/M,35 S-SP/M,50 S-SP/M,55 S-SP/M,75 S-SP/M,100 S-SP/M,125 S-SP/M,150 S-SP/M,175 S-SP/M,200	Separator, 35mm Separator, 50mm Separator, 55mm Separator, 75mm Separator, 100mm Separator, 125mm Separator, 150mm Separator, 175mm Separator, 200mm
	TIE WRAP	S-TW050/035N,50 S-TW050/035N,75 S-TW050/035N,100 S-TW050/035N,125 S-TW050/035N,150 S-TW050/035N,175 S-TW050/035N,200	Tie wrap for end bracket to fix cables, 50mm Tie wrap for end bracket to fix cables, 75mm Tie wrap for end bracket to fix cables, 100mm Tie wrap for end bracket to fix cables, 125mm Tie wrap for end bracket to fix cables, 150mm Tie wrap for end bracket to fix cables, 175mm Tie wrap for end bracket to fix cables, 200mm
	SYSTEM TIE WRAP	sb-DV035/W S-TW,EB035	Divider for fixing cables at end bracket System tie wrap to arrange for cables right after moving bracket or fixing bracket

Model	Classification	Part number	Description
ST072N	SIDE BAND	ST-SB072N/E(LH) ST-SB072N/E(RH)	Left side band of ST072N Right side band of ST072N
	BENDING RADIUS	ST-BR055.R65,75,100,125,150,200	Bending radius unit for side band
	FRAME PIN	S-FP/S1	Frame pin
	FRAME	sb-FR045,50 sb-FR045,75 sb-FR045,100 sb-FR045,125 sb-FR045,140 sb-FR045,150 sb-FR045,165 sb-FR045,175 sb-FR045,190 sb-FR045,200 sb-FR045,240 sb-FR045,250 sb-FR045,300	Frame, 50mm Frame, 75mm Frame, 100mm Frame, 125mm Frame, 140mm Frame, 150mm Frame, 165mm Frame, 175mm Frame, 190mm Frame, 200mm Frame, 240mm Frame, 250mm Frame, 300mm
	FREE END BRACKET	ST-FEB072N/S sb-FEB/WH045	End bracket of ST072N Steel washer for end bracket
	DIVIDER	sb-DV045/M sb-DV045/S sb-DV045/T sb-DV045/TP	Normal divider To fix separstors at the both side section T divider T divider pin
	SEPARATOR	sb-SP/400,400 SP-PIN045	Separator, 400mm Separator pin to fix
	TIE WRAP	S-TW50 S-TW75 S-TW100 S-TW125 S-TW150	Tie wrap for end bracket to fix cables, 50mm Tie wrap for end bracket to fix cables, 75mm Tie wrap for end bracket to fix cables, 100mm Tie wrap for end bracket to fix cables, 125mm Tie wrap for end bracket to fix cables, 150mm
	SYSTEM TIE WRAP	sb-DV045/W S-TW,EB045	Divider for fixing cables at end bracket System tie wrap to arrange for cables right after moving bracket or fixing bracket

Model	Classification	Part number	Description
ST095N	SIDE BAND	ST-SB095N/E(LH) ST-SB095N/E(RH)	Left side band of ST095N Right side band of ST095N
	BENDING RADIUS	ST-BR055,R65,75,100,125,150,200	Bending radius unit for side band
	FRAME PIN	S-FP/S1	Frame Pin
	FRAME	sb-FR060,75	Frame, 75mm
		sb-FR060,100	Frame, 100mm
		sb-FR060,125	Frame, 125mm
		sb-FR060,150	Frame, 150mm
		sb-FR060,175	Frame, 175mm
		sb-FR060,190	Frame, 190mm
		sb-FR060,200	Frame, 200mm
sb-FR060,230		Frame, 230mm	
sb-FR060,250		Frame, 250mm	
sb-FR060,300		Frame, 300mm	
sb-FR060,350	Frame, 350mm		
sb-FR060,400	Frame, 400mm		
FREE END BRACKET	ST-FEB095N/S sb-FEB/WH060	End bracket of ST095N Steel washer for end bracket	
DIVIDER	sb-DV060/M	Normal divider	
	sb-DV060/S	To fix separstors at the both side section	
	sb-DV060/T	T divider	
	sb-DV060/TP	T divider pin	
SEPARATOR	sb-SP/400,400	Separator, 400mm	
	SP-PIN060	Separator pin to fix	
TIE WRAP	S-TW50	Tie wrap for end bracket to fix cables, 50mm	
	S-TW75	Tie wrap for end bracket to fix cables, 75mm	
	S-TW100	Tie wrap for end bracket to fix cables, 100mm	
	S-TW125	Tie wrap for end bracket to fix cables, 125mm	
	S-TW150	Tie wrap for end bracket to fix cables, 150mm	
SYSTEM TIE WRAP	sb-DV060/W S-TWEB060	Divider for fixing cables at end bracket System tie wrap to arrange for cables right after moving bracket or fixing bracket	

Model	Classification	Part number	Description
ST120N	SIDE BAND	ST-SB120N/E(LH) ST-SB120N/E(RH)	Left side band of ST120N Right side band of ST120N
	BENDING RADIUS	ST-BR120,R180, 200, 250, 300, 350, 400, 500	Bending radius unit for side band
	FRAME PIN	S-FP/S2	Frame Pin
	FRAME	sb-FR075/100,75	Frame, 75mm
		sb-FR075/100,100	Frame, 100mm
		sb-FR075/100,115	Frame, 115mm
		sb-FR075/100,125	Frame, 125mm
		sb-FR075/100,150	Frame, 150mm
		sb-FR075/100,175	Frame, 175mm
		sb-FR075/100,200	Frame, 200mm
sb-FR075/100,240		Frame, 240mm	
sb-FR075/100,250		Frame, 250mm	
sb-FR075/100,290		Frame, 290mm	
sb-FR075/100,300		Frame, 300mm	
sb-FR075/100,350		Frame, 350mm	
sb-FR075/100,400		Frame, 400mm	
sb-FR075/100,450		Frame, 450mm	
sb-FR075/100,500		Frame, 500mm	
sb-FR075/100,550		Frame, 550mm	
sb-FR075/100,600		Frame, 600mm	
FREE END BRACKET	ST-FEB120N/S sb-FEB/WH075	End bracket of ST120N Steel washer for end bracket	
DIVIDER	sb-DV075/M	Normal divider	
	sb-DV075/S	To fix separstors at the both side section	
	sb-DV075/T	T divider	
	sb-DV075/TP	T divider pin	
SEPARATOR	sb-SP/400,400	Separator, 400mm	
	SP-PIN075	Separator pin to fix	
TIE WRAP	S-TW50	Tie wrap for end bracket to fix cables, 50mm	
	S-TW75	Tie wrap for end bracket to fix cables, 75mm	
	S-TW100	Tie wrap for end bracket to fix cables, 100mm	
	S-TW125	Tie wrap for end bracket to fix cables, 125mm	
	S-TW150	Tie wrap for end bracket to fix cables, 150mm	
SYSTEM TIE WRAP	sb-DV075/W S-TWEB075	Divider for fixing cables at end bracket System tie wrap to arrange for cables right after moving bracket or fixing bracket	

Model	Classification	Part number	Description
ST150N	SIDE BAND	ST-SB150N/E(LH) ST-SB150N/E(RH)	Left side band of ST150N Right side band of ST150N
	BENDING RADIUS	ST-BR150,R205,305,405,505,605	Bending radius unit for side band
	FRAME PIN	S-FP/S2	Frame Pin
	FRAME	sb-FR075/100,75	Frame, 75mm
		sb-FR075/100,100	Frame, 100mm
		sb-FR075/100,115	Frame, 115mm
		sb-FR075/100,125	Frame, 125mm
		sb-FR075/100,150	Frame, 150mm
		sb-FR075/100,175	Frame, 175mm
		sb-FR075/100,200	Frame, 200mm
sb-FR075/100,240		Frame, 240mm	
sb-FR075/100,250		Frame, 250mm	
sb-FR075/100,290		Frame, 290mm	
sb-FR075/100,300		Frame, 300mm	
sb-FR075/100,350		Frame, 350mm	
sb-FR075/100,400		Frame, 400mm	
sb-FR075/100,450		Frame, 450mm	
sb-FR075/100,500		Frame, 500mm	
sb-FR075/100,550		Frame, 550mm	
sb-FR075/100,600		Frame, 600mm	
STEEL END BRACKET	ST-SEB150N/B1-B2-B3	Steel end bracket of ST150N	
DIVIDER	sb-DV075/M	Normal divider	
	sb-DV075/S	To fix separstors at the both side section	
	sb-DV075/T	T divider	
	sb-DV075/TP	T divider pin	
SEPARATOR	sb-SP/600,600	Separator, 600mm	
	SP-PIN100	Separator pin to fix	
TIE WRAP	S-TW50	Tie wrap for end bracket to fix cables, 50mm	
	S-TW75	Tie wrap for end bracket to fix cables, 75mm	
	S-TW100	Tie wrap for end bracket to fix cables, 100mm	
	S-TW125	Tie wrap for end bracket to fix cables, 125mm	
	S-TW150	Tie wrap for end bracket to fix cables, 150mm	

ST 044N

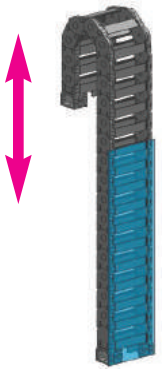
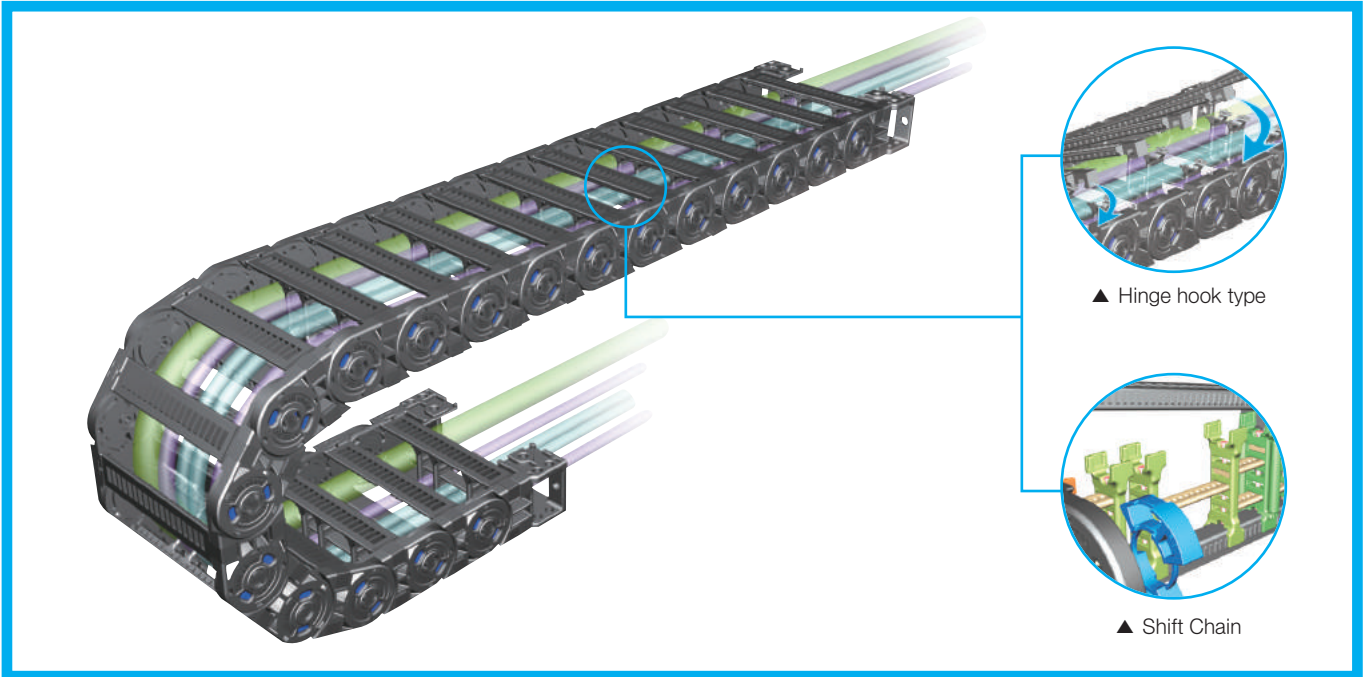

Vertical with curve above

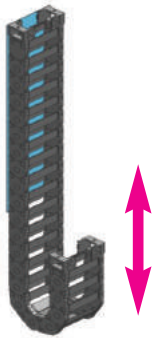

Vertical with curve below

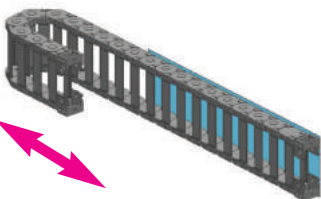

Horizontal application mounted on its side

» Calculation of the chain length

$$\left[L = \frac{L_s}{2} + L_p \right]$$

» Other installation length

Vertical curve above = max 2.0m

Vertical curve below = max 40m

Side Mounted, Unsupported = max 1.0m

» Load diagrams self-supporting length

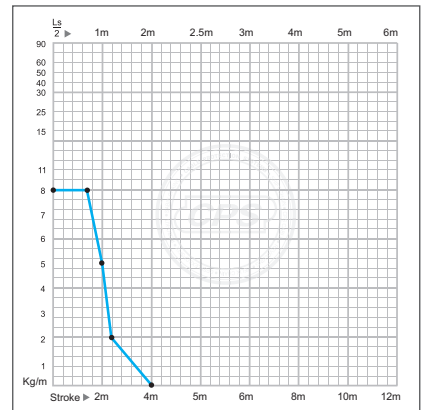

» Layout of the chain

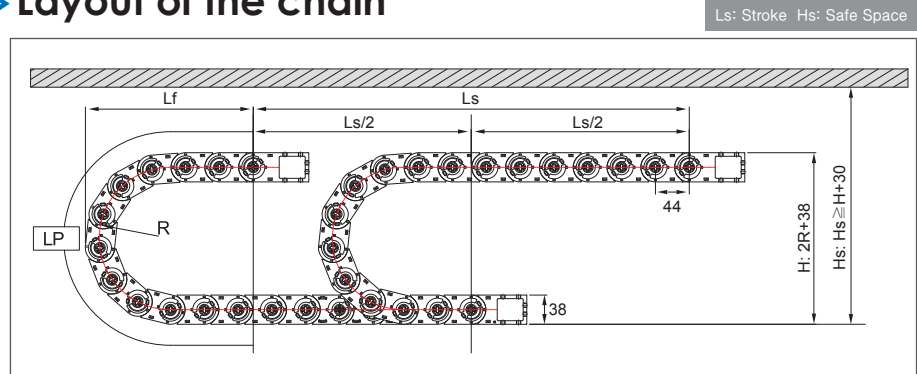

Bending Radius (R)	Lp Loop Length	Lf Loof Projection	H Moving Height
50	333	157	138
70	396	177	178
90	459	197	218
120	553	227	278
150	648	257	338

(Dimensions in mm)

» Chain cross section

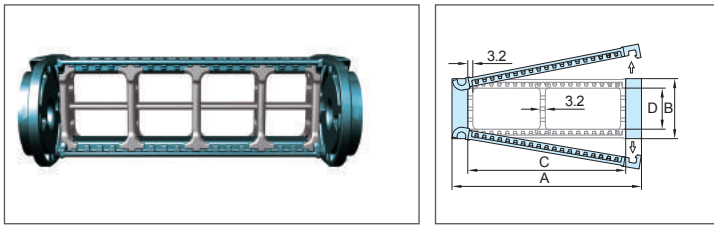

Chain Type	A Width (Outer)	B Height (Outer)	C Frame	D Height (Inner)	Weight kg/m
ST 044N	56	38	35	26	0,93
	71		50		0,97
	76		55		1,00
	96		75		1,06
	121		100		1,17
	146		125		1,30
	171		150		1,43
	196		175		1,78
221	200	1,94			

(Dimensions in mm)

» Free end bracket

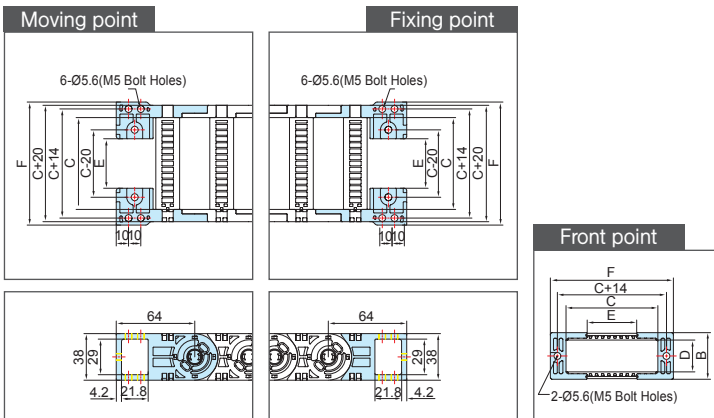

Chain Type	F Width(Outer)	B Height(Outer)	C Frame	D Height(Inner)	E M,EB Bolt hole width	Hole Type
ST 044N	60,4	38	35	26	0,4	M5 Bolt Holes
	75,4		50		15,4	
	80,4		55		20,4	
	100,4		75		40,4	
	125,4		100		65,4	
	150,4		125		90,4	
	175,4		150		115,4	
	200,4		175		140,4	
225,4	200	165,4				

(Dimensions in mm)

» System tie wrap (STW)

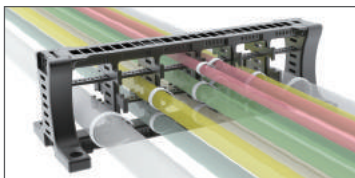

It is a unit to classify each cable for preventing entanglement of cables. It can either be installed to free end bracket or installed separately according its application environment.

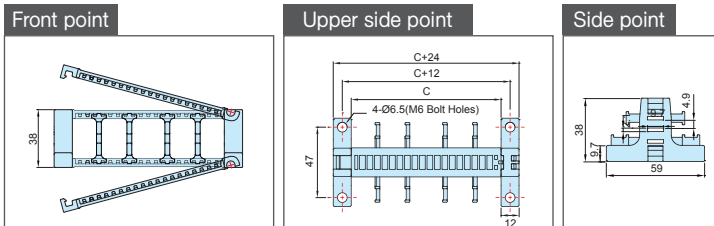

Chain Type	Ordering No.	C Frame	Hole Type
ST 044N	S-TW,EB028,35	35	M6 Bolt Holes
	S-TW,EB028,50	50	
	S-TW,EB028,55	55	
	S-TW,EB028,75	75	
	S-TW,EB028,100	100	
	S-TW,EB028,125	125	
	S-TW,EB028,150	150	
	S-TW,EB028,175	175	
	S-TW,EB028,200	200	

(Dimensions in mm)

» Dividers(DV)

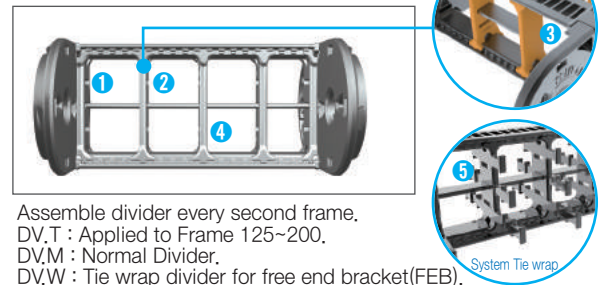

Assemble divider every second frame.
DV.T : Applied to Frame 125~200.
DV.M : Normal Divider.
DV.W : Tie wrap divider for free end bracket(FEB).

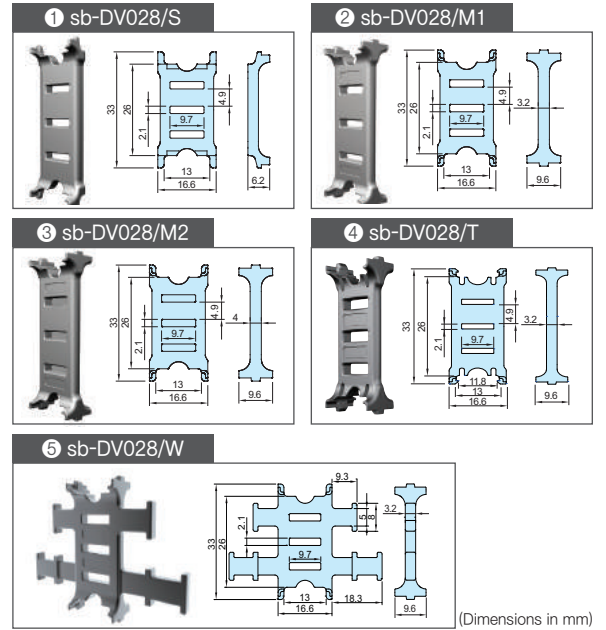

(Dimensions in mm)

» Separators(SP)

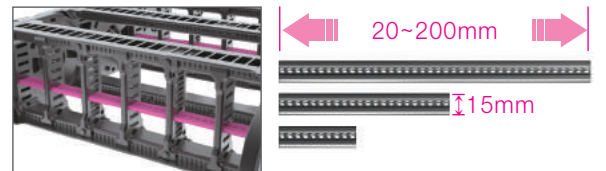

Chain Type	Ordering NO.	Frame
ST 044N	S-SP/M,35	35
	S-SP/M,50	50
	S-SP/M,55	55
	S-SP/M,75	75
	S-SP/M,100	100
	S-SP/M,125	125
	S-SP/M,150	150
	S-SP/M,175	175
	S-SP/M,200	200

» Tie wrap (TW)

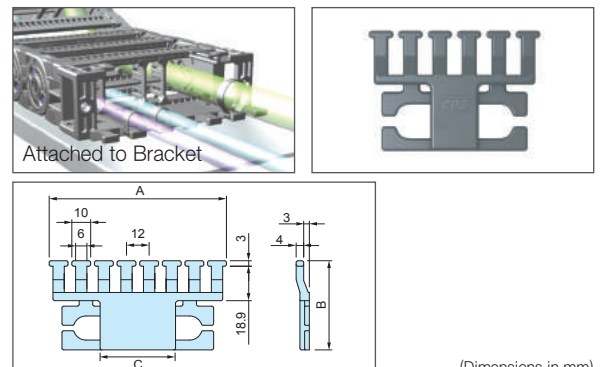

(Dimensions in mm)

Chain Type	Ordering No.	A	B	C
ST 044N	S-TW036/025CR,35	46	35,4	-
	S-TW036/025CR,50	69	48,9	15
	S-TW036/025CR,55	70	48,9	20
	S-TW036/025CR,75	94	48,9	40
	S-TW036/025CR,100	118	48,9	65
	S-TW036/025CR,125	142	48,9	90

ST 055N

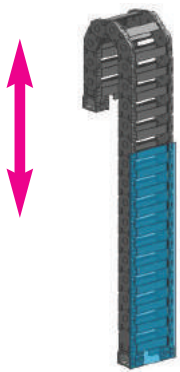
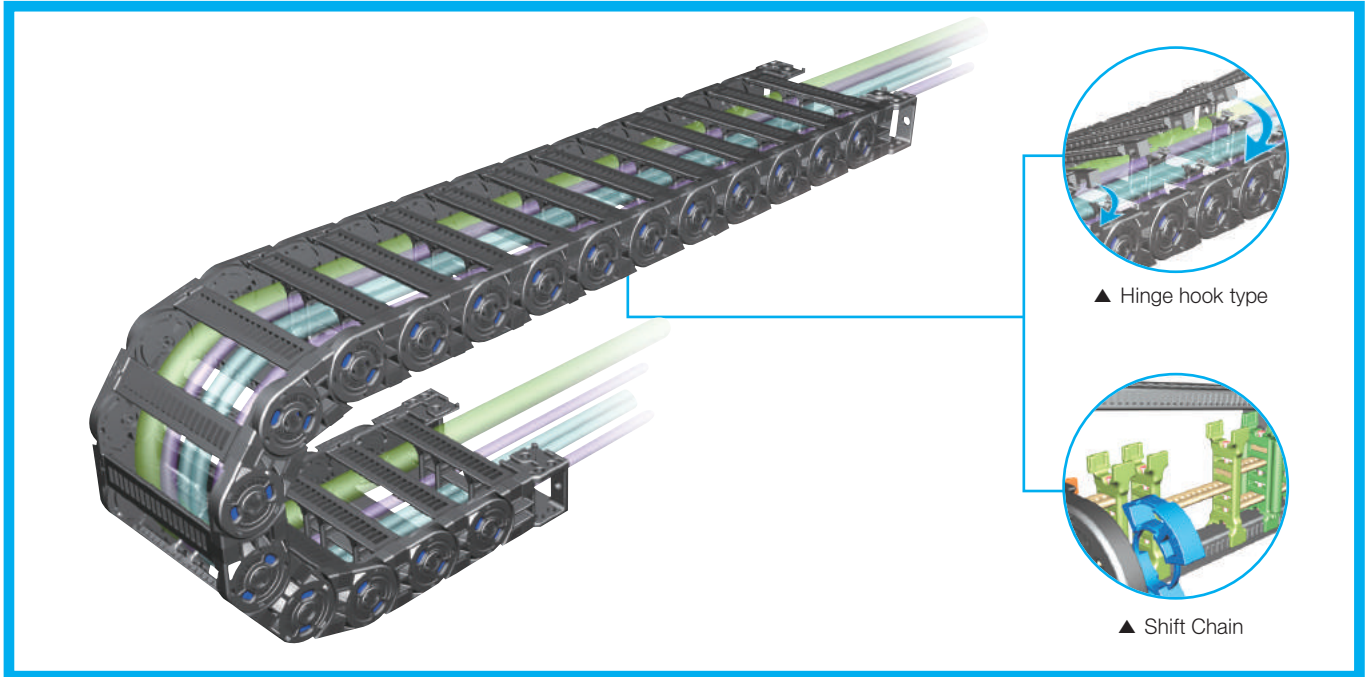

Vertical with curve above

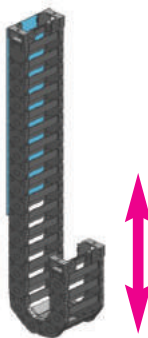

Vertical with curve below

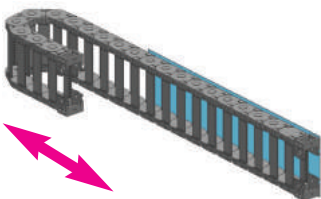

Horizontal application mounted on its side

» Calculation of the chain length

$$\left[L = \frac{L_s}{2} + L_p \right]$$

» Other installation length

Vertical curve above = max 3.0m

Vertical curve below = max 50m

Side Mounted, Unsupported = max 1.0m

» Load diagrams self-supporting length

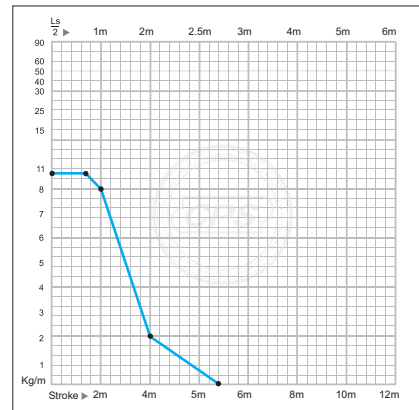

» Layout of the chain

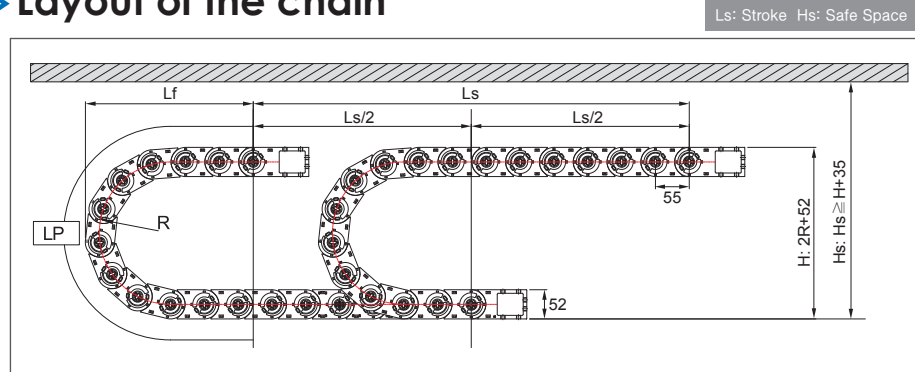

Bending Radius (R)	Lp Loop Length	Lf Loof Projection	H Moving Height
65	424	201	182
75	456	211	202
100	535	236	252
125	613	261	302
150	692	286	352
200	849	336	452

(Dimensions in mm)

» Chain cross section

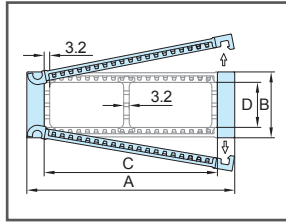
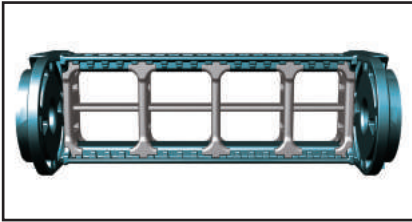

Chain Type	A Width (Outer)	B Height (Outer)	C Frame	D Height (Inner)	Weight kg/m
ST 055N	56	52	35	40	1.12
	71		50		1.15
	76		55		1.18
	96		75		1.23
	121		100		1.31
	146		125		1.41
	171		150		1.51
	196		175		1.78
221	200	1.92			

(Dimensions in mm)

» Free end bracket

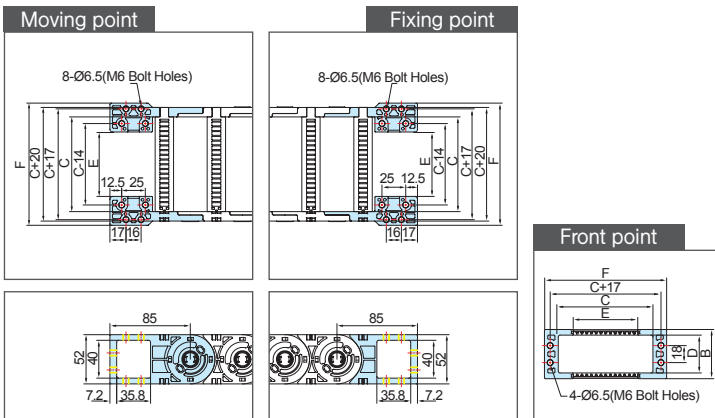

Chain Type	F Width(Outer)	B Height(Outer)	C Frame	D Height(Inner)	E M,EB Bolt hole width	Hole Type
ST 055N	64	52	35	40	3	M6 Bolt Holes
	79		50		18	
	84		55		23	
	104		75		43	
	129		100		68	
	154		125		93	
	179		150		118	
	204		175		143	
229	200	168				

(Dimensions in mm)

» System tie wrap (STW)

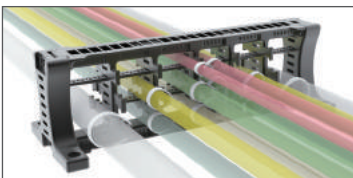

It is a unit to classify each cable for preventing entanglement of cables. It can either be installed to free end bracket or installed separately according its application environment.

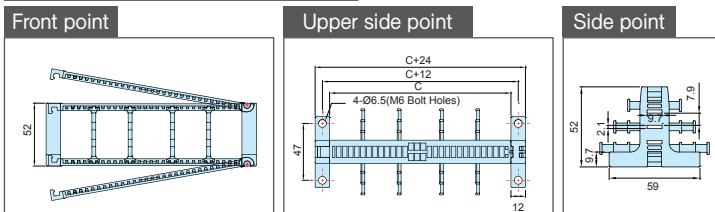

Chain Type	Ordering No.	C Frame	Hole Type
ST 055N	S-TWEB035,35	35	M6 Bolt Holes
	S-TWEB035,50	50	
	S-TWEB035,55	55	
	S-TWEB035,75	75	
	S-TWEB035,100	100	
	S-TWEB035,125	125	
	S-TWEB035,150	150	
	S-TWEB035,175	175	
	S-TWEB035,200	200	

(Dimensions in mm)

» Dividers(DV)

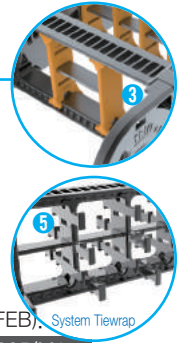
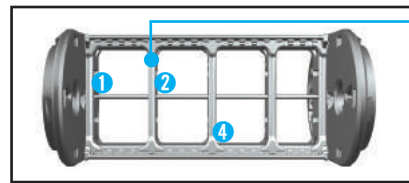

Assemble divider every second frame.
 DV.T : Applied to Frame 125~200.
 DV.M : Normal Divider.
 DV.W : Tie wrap divider for free end bracket(FEB), System Tiewrap

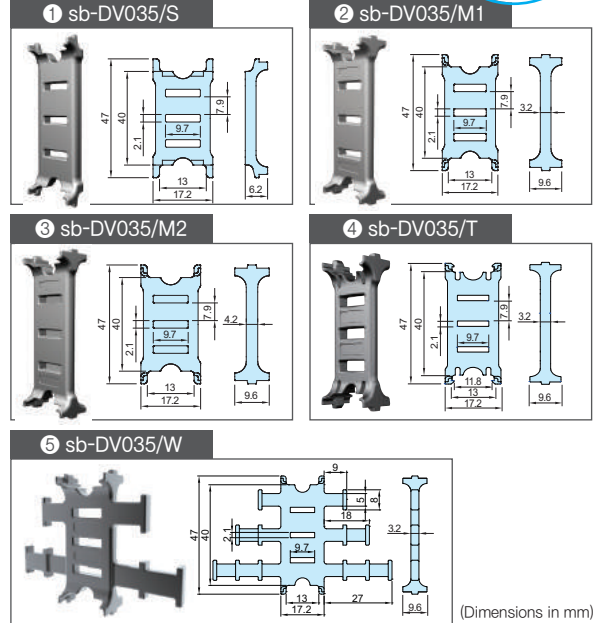

(Dimensions in mm)

» Separators(SP)

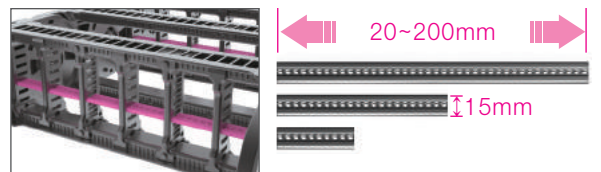

Chain Type	Ordering NO.	Frame
ST 055N	S-SP/M,35	35
	S-SP/M,50	50
	S-SP/M,55	55
	S-SP/M,75	75
	S-SP/M,100	100
	S-SP/M,125	125
	S-SP/M,150	150
	S-SP/M,175	175
	S-SP/M,200	200

» Tie wrap (TW)

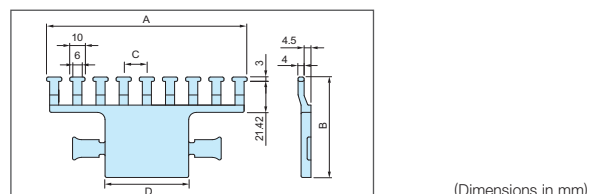

(Dimensions in mm)

Chain Type	Ordering No.	A	B	C	D
ST 055N	S-TW050/035N,50	82	64.5	12.00	5
	S-TW050/035N,55	82		12.00	10
	S-TW050/035N,75	107		12.13	30
	S-TW050/035N,100	132		15.25	55
	S-TW050/035N,125	157		14.70	80
	S-TW050/035N,150	182		14.35	105
	S-TW050/035N,175	203		12.31	130
	S-TW050/035N,200	232		13.88	155

ST 072N

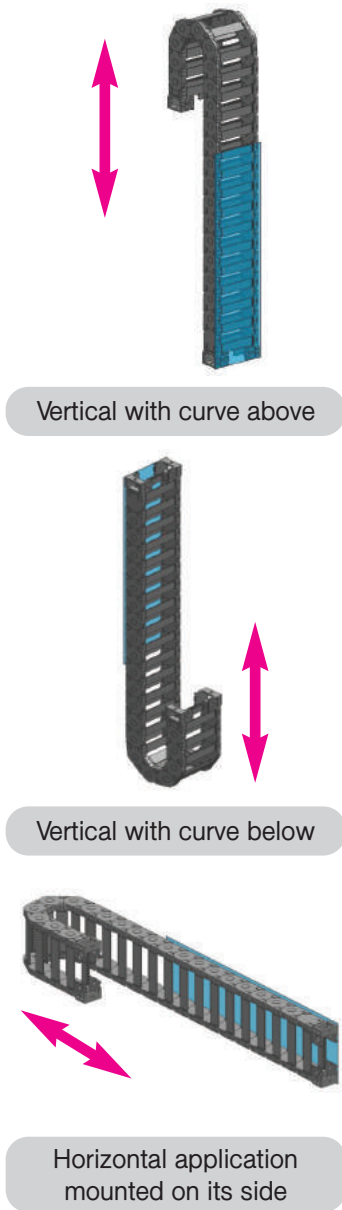
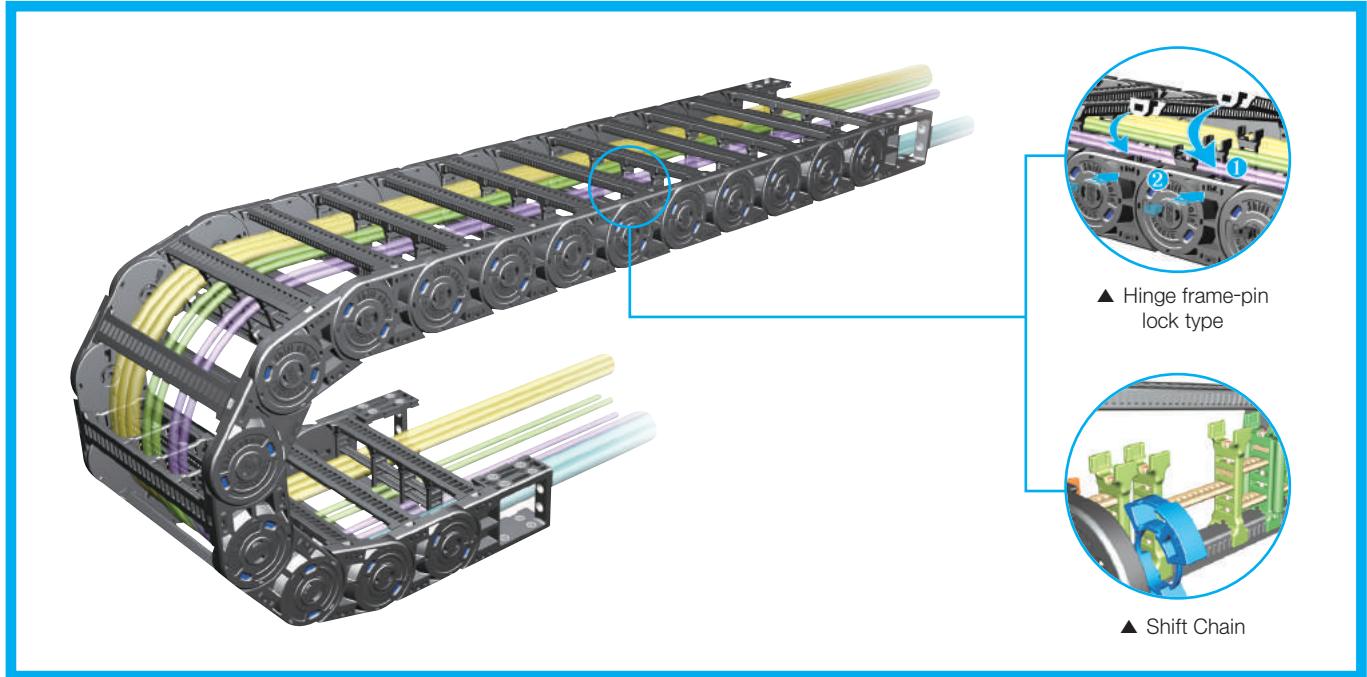

» Calculation of the chain length

$$\left[L = \frac{L_s}{2} + L_p \right]$$

» Other installation length

Vertical curve above = max 6.0m
 Vertical curve below = max 100m
 Side Mounted, Unsupported = max 2.5m

» Load diagrams self-supporting length

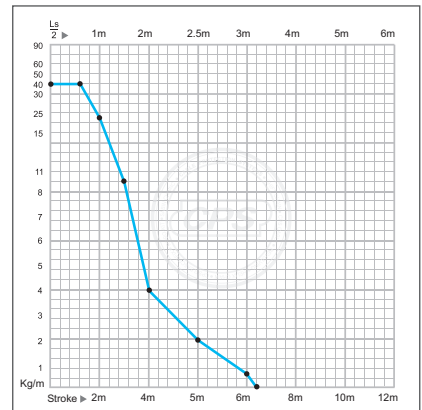

» Layout of the chain

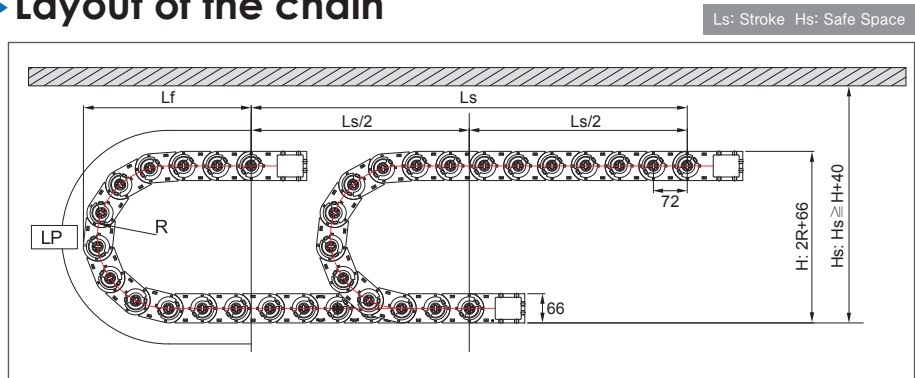

Bending Radius (R)	Lp Loop Length	Lf Loof Projection	H Moving Height
72	514	249	210
100	603	277	266
120	665	297	306
145	743	322	356
200	916	377	466
250	1,074	427	566
300	1,230	477	666

(Dimensions in mm)

» Chain cross section

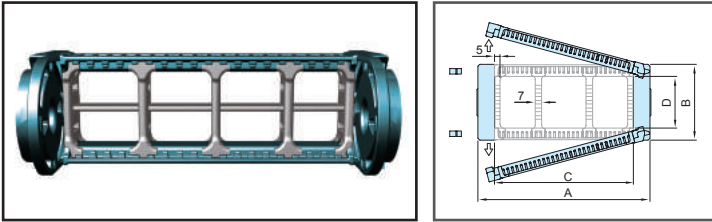

Chain Type	A Width (Outer)	B Height (Outer)	C Frame	D Height (Inner)	Weight kg/m
ST 072N	82	66	50	45	2.10
	107		75		2.20
	132		100		2.30
	157		125		2.43
	172		140		2.51
	182		150		2.56
	197		165		2.62
	207		175		2.66
	222		190		2.93
	232		200		3.11
	272		240		3.21
	282		250		3.24
	332		300		3.60

(Dimensions in mm)

» Free end bracket

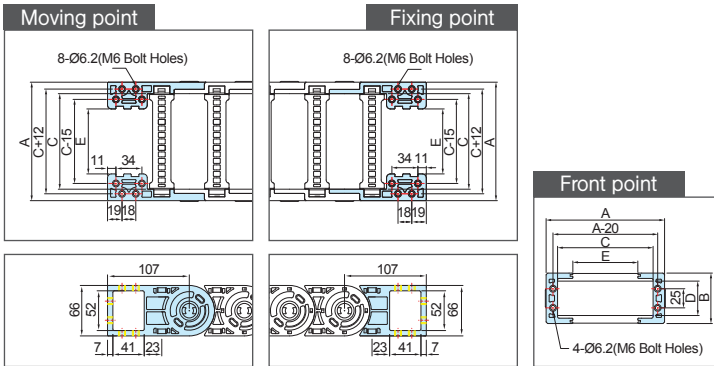

Chain Type	A Width(Outer)	B Height(Outer)	C Frame	D Height(Inner)	E M,EB Bolt hole width	Hole Type
ST 072N	82	66	50	45	10	M6 Bolt Holes
	107		35			
	132		60			
	157		85			
	172		100			
	182		110			
	197		125			
	207		135			
	222		150			
	232		160			
	272		200			
	282		210			
	332		260			

(Dimensions in mm)

» System tie wrap (STW)

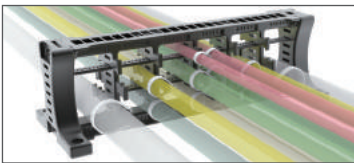

It is a unit to classify each cable for preventing entanglement of cables. It can either be installed to free end bracket or installed separately according its application environment.

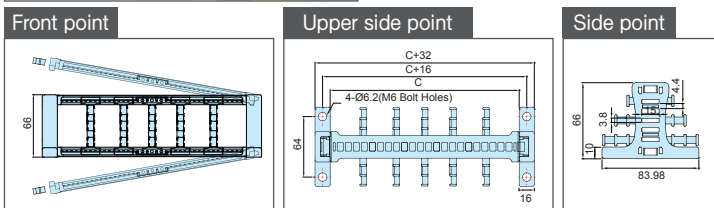

Chain Type	Ordering No.	C Frame	Hole Type
ST 072N	S-TW,EB045.50	50	M6 Bolt Holes
	S-TW,EB045.75	75	
	S-TW,EB045.100	100	
	S-TW,EB045.125	125	
	S-TW,EB045.140	140	
	S-TW,EB045.150	150	
	S-TW,EB045.165	165	
	S-TW,EB045.175	175	
	S-TW,EB045.190	190	
	S-TW,EB045.200	200	
	S-TW,EB045.240	240	
	S-TW,EB045.250	250	
	S-TW,EB045.300	300	

(Dimensions in mm)

» Dividers(DV)

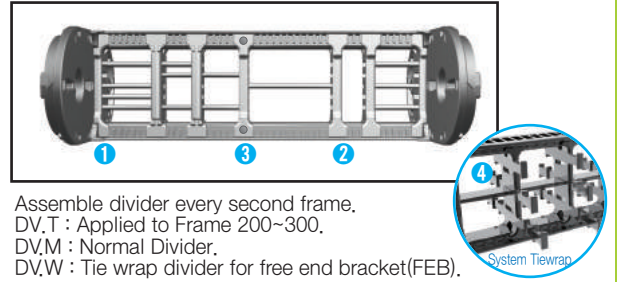

Assemble divider every second frame.
DV.T : Applied to Frame 200~300.
DV.M : Normal Divider.
DV.W : Tie wrap divider for free end bracket(FEB).

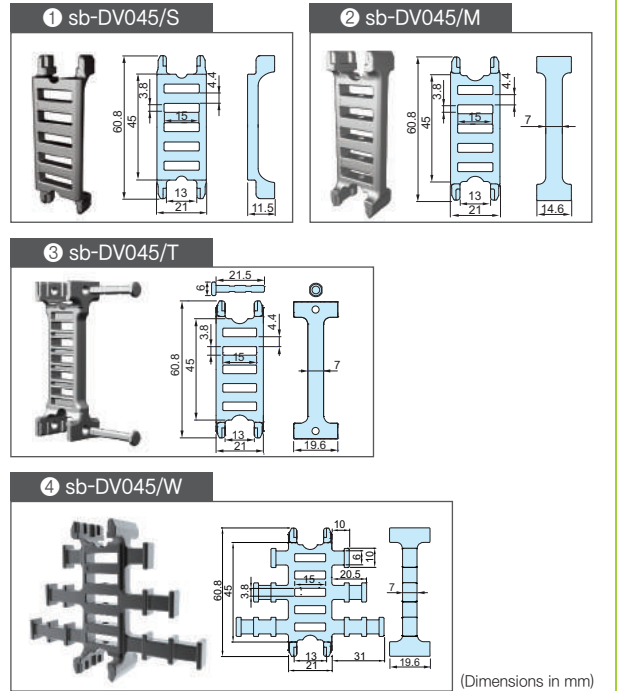

(Dimensions in mm)

» Separators(SP)

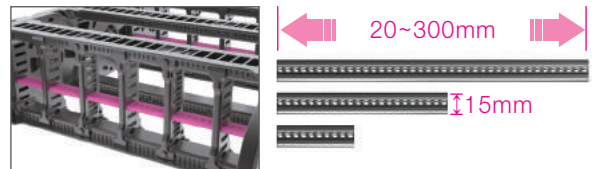

Chain Type	Ordering NO.
ST 072N	sb-SP/400,400

» Tie wrap (TW)

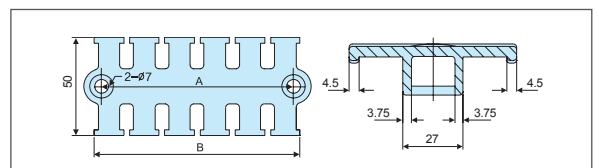
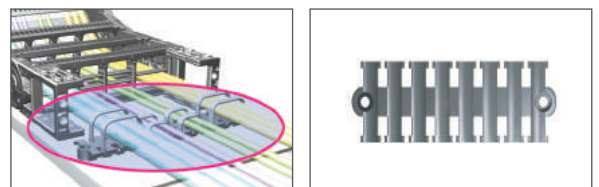

Chain Type	Ordering No.	A	B
ST 072N	S-TW50	58	65
	S-TW75	75	82
	S-TW100	98	105
	S-TW125	122	129
	S-TW150	141	148

(Dimensions in mm)

ST 095N

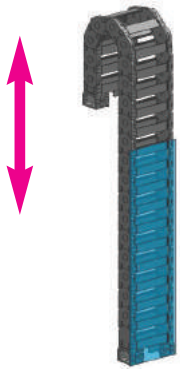
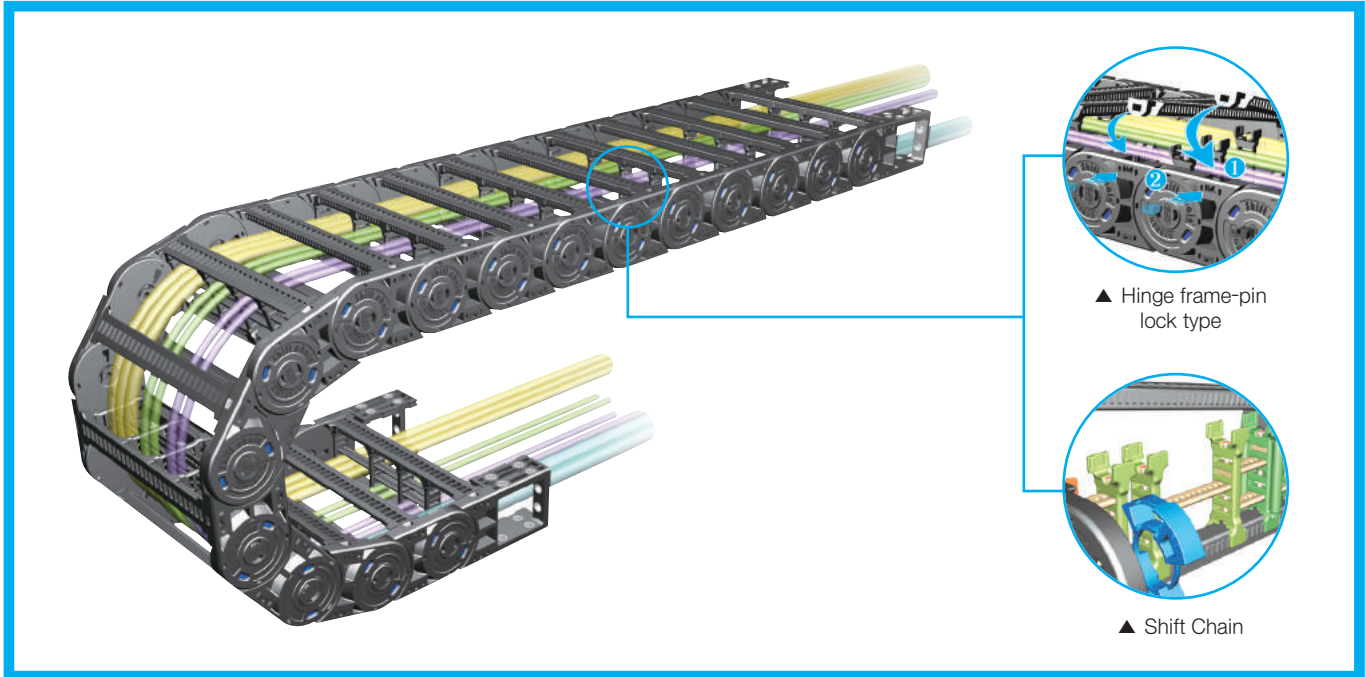

Vertical with curve above

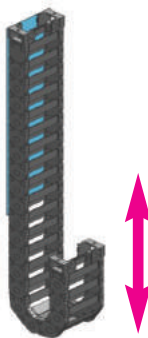

Vertical with curve below

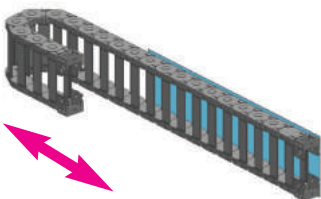

Horizontal application mounted on its side

» Calculation of the chain length

$$\left[L = \frac{L_s}{2} + L_p \right]$$

» Other installation length

Vertical curve above = max 6.0m
 Vertical curve below = max 100m
 Side Mounted, Unsupported = max 3.0m

» Load diagrams self-supporting length

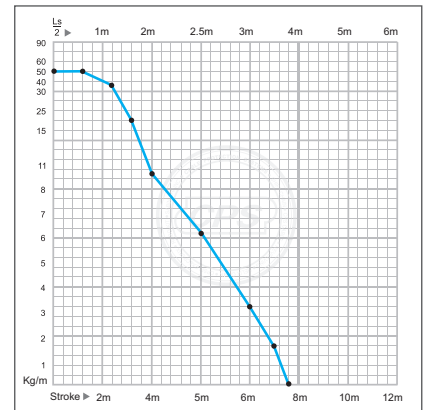

» Layout of the chain

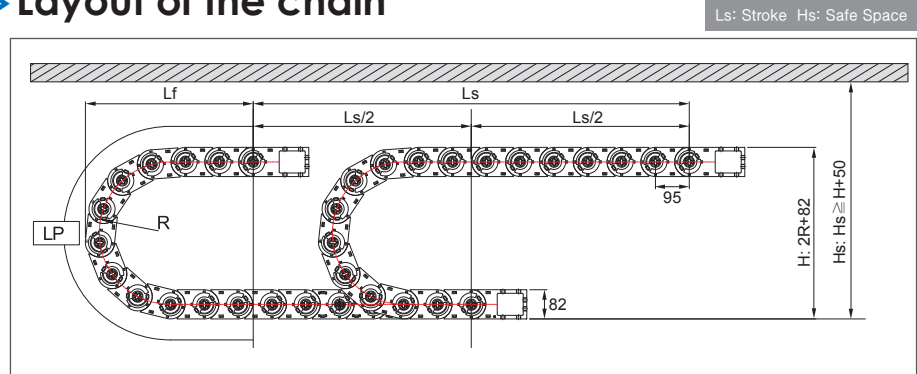

Bending Radius (R)	Lp Loop Length	Lf Loof Projection	H Moving Height
135	805	364	352
150	855	374	382
200	1,010	428	482
230	1,110	459	542
280	1,260	505	642
400	1,640	629	882

(Dimensions in mm)

» Chain cross section

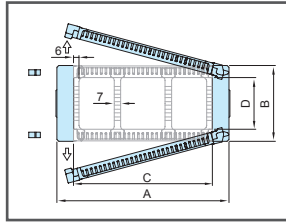
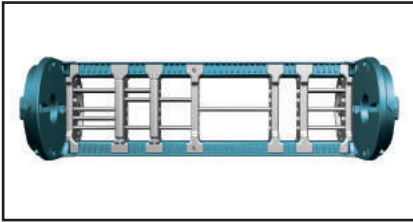

Chain Type	A Width (Outer)	B Height (Outer)	C Frame	D Height (Inner)	Weight kg/m
ST 095N	113	82	75	56	3.11
	138		100		3.17
	163		125		3.37
	188		150		3.49
	213		175		3.60
	228		190		3.71
	238		200		3.79
	268		230		3.95
	278		240		4.00
	288		250		4.05
	338		300		4.31
	388		350		4.69
	438		400		5.05

(Dimensions in mm)

» Free end bracket

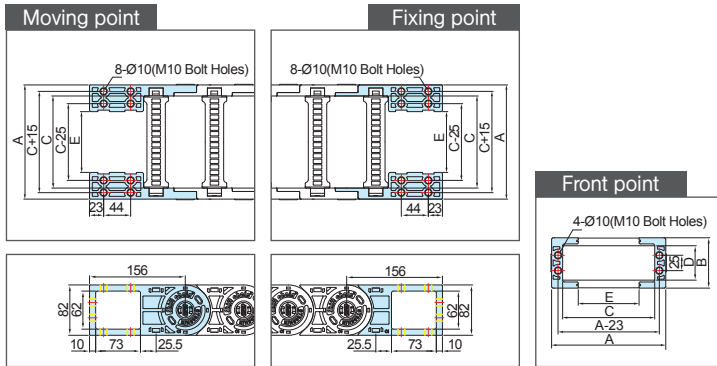

Chain Type	A Width(Outer)	B Height(Outer)	C Frame	D Height(Inner)	E M,EB Bolt hole width	Hole Type
ST 095N	113	82	75	56	24	M10 Bolt Holes
	138		100		49	
	163		125		74	
	188		150		99	
	213		175		124	
	228		190		139	
	238		200		149	
	268		230		179	
	278		240		189	
	288		250		199	
	338		300		249	
	388		350		299	
	438		400		349	

(Dimensions in mm)

» System tie wrap (STW)

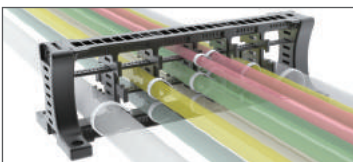

It is a unit to classify each cable for preventing entanglement of cables. It can either be installed to free end bracket or installed separately according its application environment.

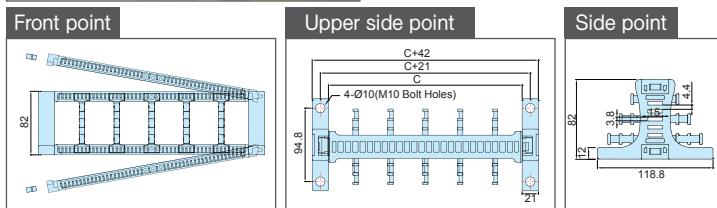

Chain Type	Ordering No.	C Frame	Hole Type
ST 095N	S-TW,EB060.75	75	M10 Bolt Holes
	S-TW,EB060.100	100	
	S-TW,EB060.125	125	
	S-TW,EB060.150	150	
	S-TW,EB060.175	175	
	S-TW,EB060.190	190	
	S-TW,EB060.200	200	
	S-TW,EB060.230	230	
	S-TW,EB060.240	240	
	S-TW,EB060.250	250	
	S-TW,EB060.300	300	
	S-TW,EB060.350	350	
	S-TW,EB060.400	400	

(Dimensions in mm)

» Dividers(DV)

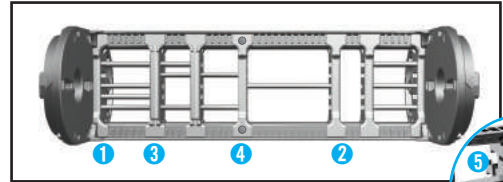

Assemble divider every second frame.
 DV.T : Applied to Frame 250~400.
 DV.M : Normal Divider.
 DV.W : Tie wrap divider for free end bracket(FEB).

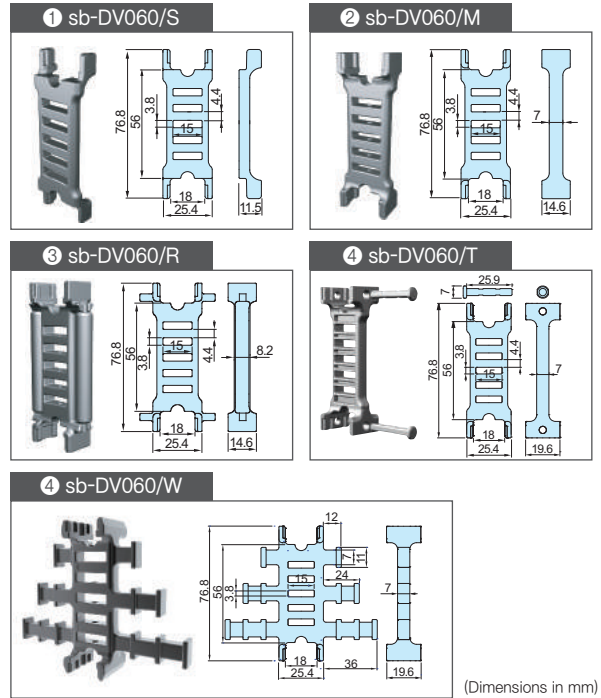
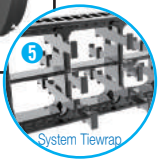

(Dimensions in mm)

» Separators(SP)

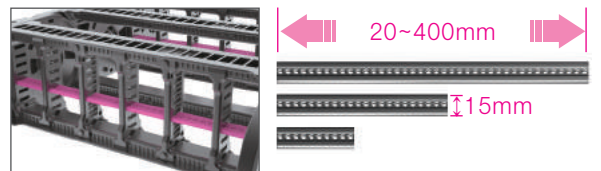

Chain Type	Ordering NO.
ST 095N	sb-SP/400,400

» Tie wrap (TW)

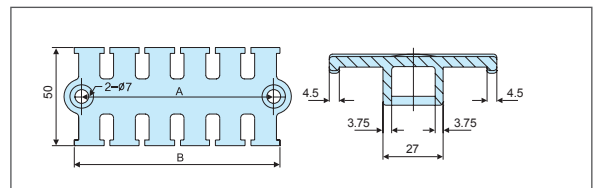
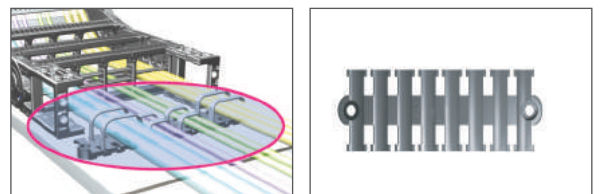

Chain Type	Ordering No.	A	B
ST 095N	S-TW50	58	65
	S-TW75	75	82
	S-TW100	98	105
	S-TW125	122	129
	S-TW150	141	148

(Dimensions in mm)

ST 120N

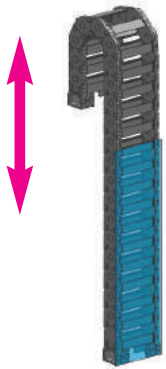
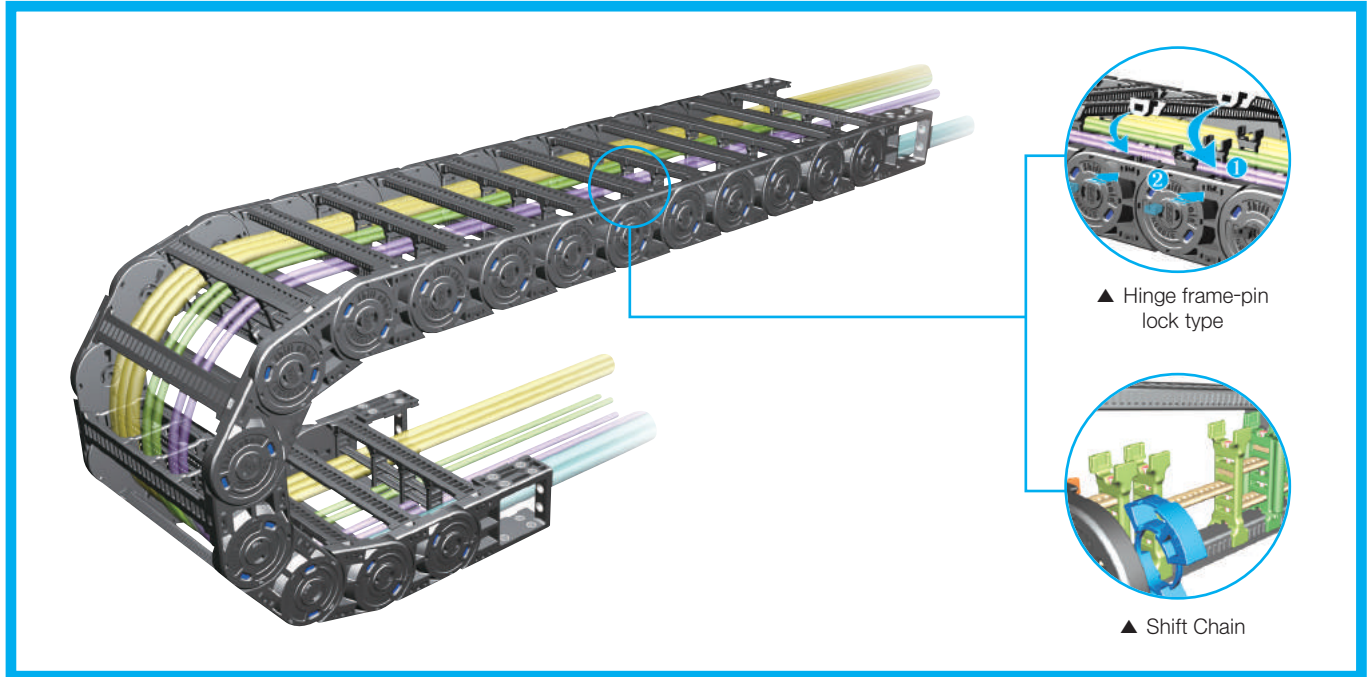

Vertical with curve above

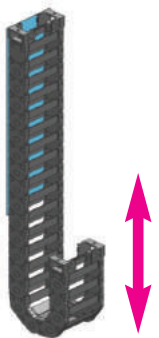

Vertical with curve below

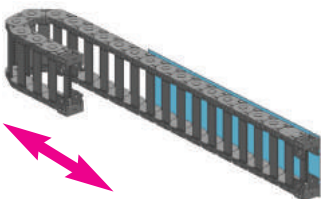

Horizontal application mounted on its side

» Calculation of the chain length

$$\left[L = \frac{L_s}{2} + L_p \right]$$

» Other installation length

Vertical curve above = max 6.0m
 Vertical curve below = max 120m
 Side Mounted, Unsupported = max 3.0m

» Load diagrams self-supporting length

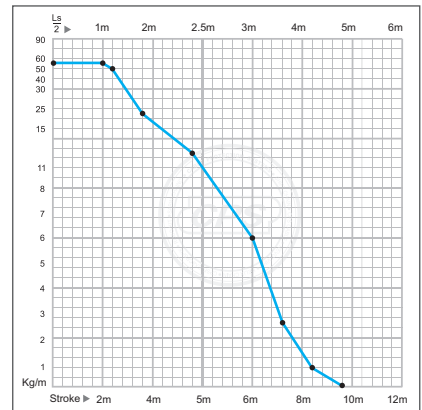

» Layout of the chain

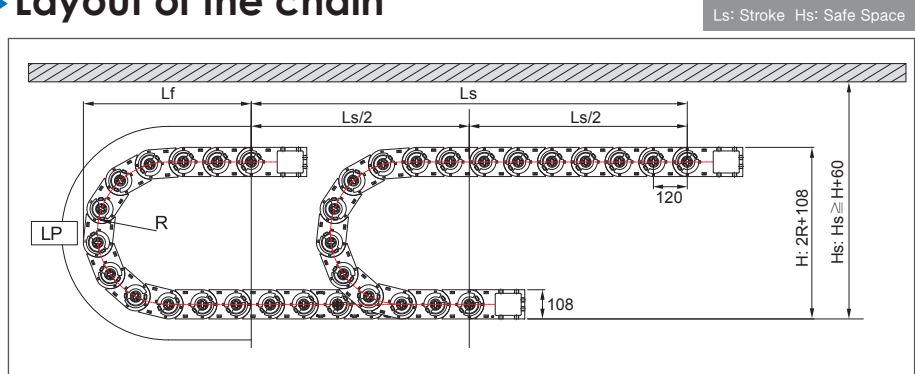

Bending Radius (R)	Lp Loop Length	Lf Loof Projection	H Moving Height
180	1,046	474	468
200	1,109	494	508
250	1,266	544	608
300	1,423	594	708
350	1,580	644	808
400	1,737	694	908
500	2,051	794	1,108

(Dimensions in mm)

» Chain cross section

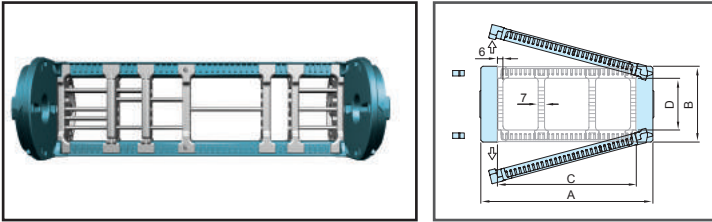

Chain Type	A Width (Outer)	B Height (Outer)	C Frame	D Height (Inner)	Weight kg/m
ST 120N	117	108	75	78	4.41
	142		100		4.53
	157		115		4.61
	167		125		4.67
	192		150		4.78
	217		175		4.93
	242		200		5.17
	282		240		5.41
	292		250		5.47
	332		290		5.80
	342		300		5.88
	392		350		6.30
	442		400		6.73
	492		450		7.07
	542		500		7.30
	592		550		8.13
642	600	8.30			

(Dimensions in mm)

» Free end bracket

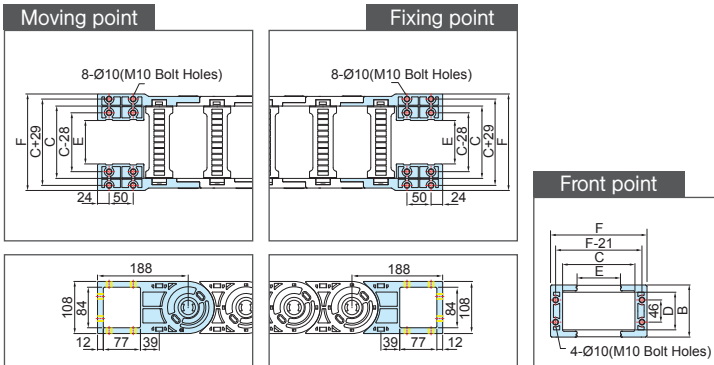

Chain Type	A Width(Outer)	B Height(Outer)	C Frame	D Height(Inner)	E M,EB Bolt hole width	Hole Type
ST 120N	125	108	75	78	15	M10 Bolt Holes
	150		100		40	
	165		115		55	
	175		125		65	
	200		150		90	
	225		175		115	
	250		200		140	
	290		240		180	
	300		250		190	
	340		290		230	
	350		300		240	
	400		350		290	
	450		400		340	
	500		450		390	
	550		500		440	
	600		550		490	
650	600	540				

(Dimensions in mm)

» System tie wrap (STW)

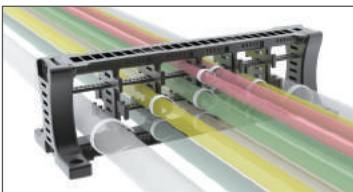

It is a unit to classify each cable for preventing entanglement of cables. It can either be installed to free end bracket or installed separately according its application environment.

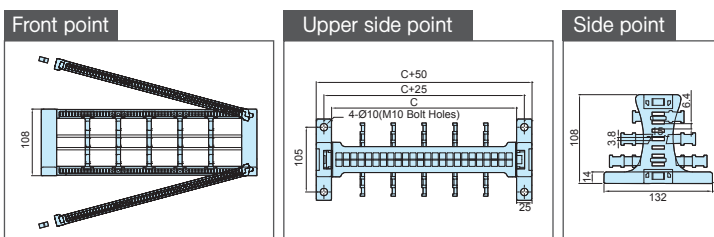

» Dividers(DV)

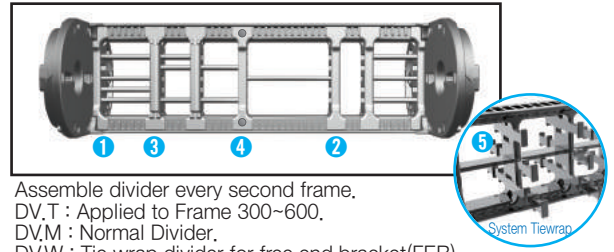

Assemble divider every second frame.
 DV.T : Applied to Frame 300~600.
 DV.M : Normal Divider.
 DV.W : Tie wrap divider for free end bracket(FEB).

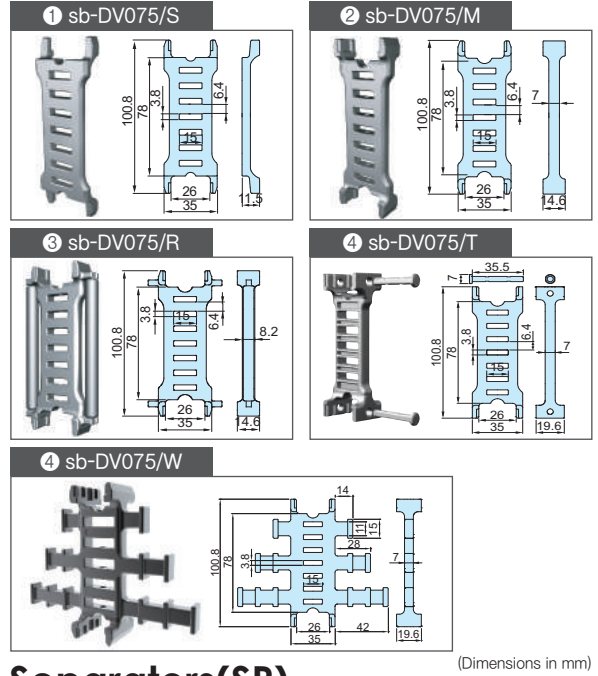

(Dimensions in mm)

» Separators(SP)

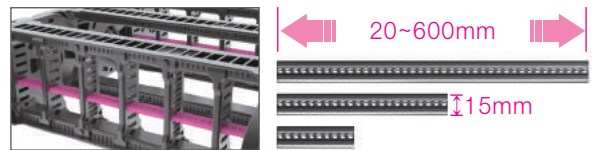

Chain Type	Ordering NO.
ST 120N	sb-SP/600,600

» Tie wrap (TW)

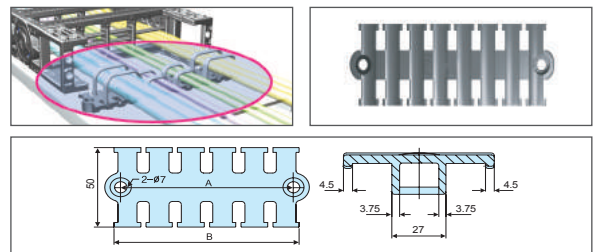

Chain Type	Ordering No.	A	B
ST 120N	S-TW50	58	65
	S-TW75	75	82
	S-TW100	98	105
	S-TW125	122	129
	S-TW150	141	148

Chain Type	Ordering No.	C Frame	Hole Type
ST 120N	S-TWEB075.75	75	M10 Bolt Holes
	S-TWEB075.100	100	
	S-TWEB075.115	115	
	S-TWEB075.125	125	
	S-TWEB075.150	150	
	S-TWEB075.175	175	
	S-TWEB075.200	200	
	S-TWEB075.240	240	
	S-TWEB075.250	250	
	S-TWEB075.290	290	
	S-TWEB075.300	300	
	S-TWEB075.350	350	
	S-TWEB075.400	400	
	S-TWEB075.450	450	
	S-TWEB075.500	500	
	S-TWEB075.550	550	
S-TWEB075.600	600		

ST 150N

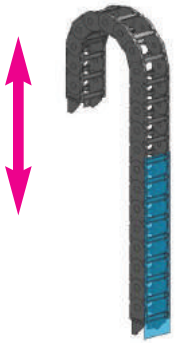
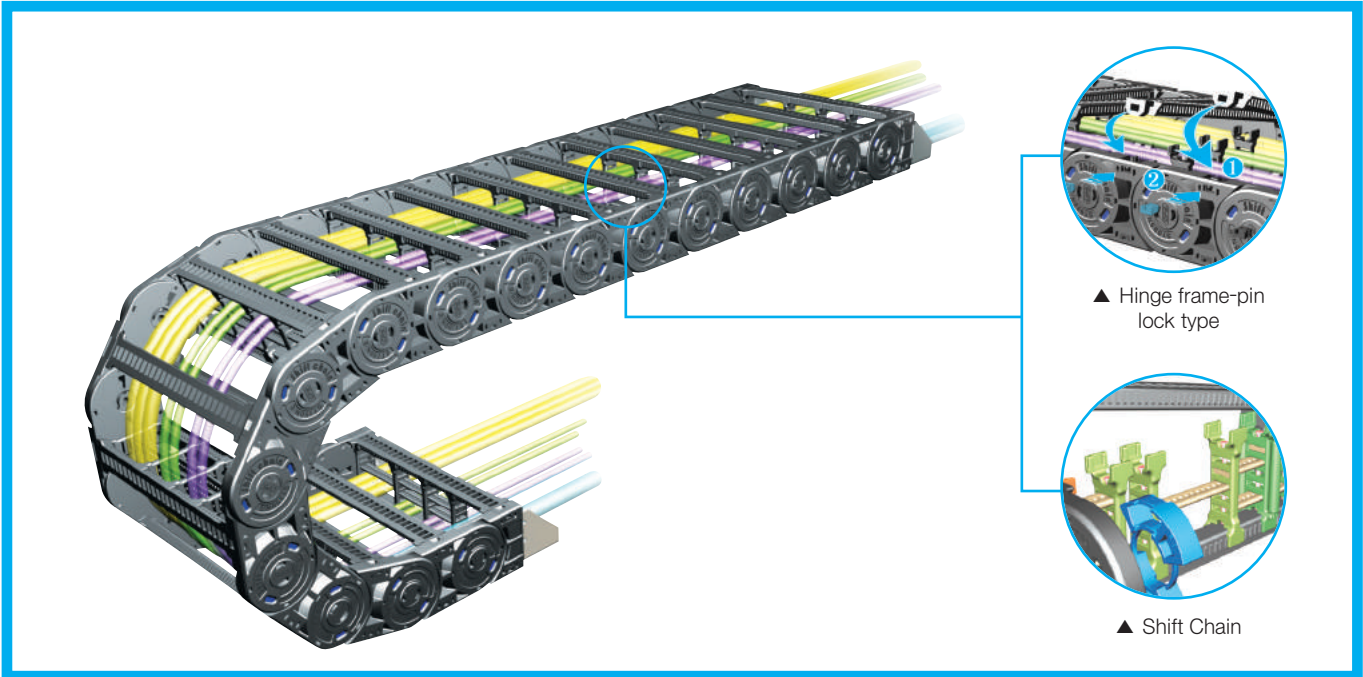

Vertical with curve above

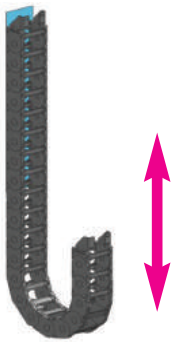

Vertical with curve below

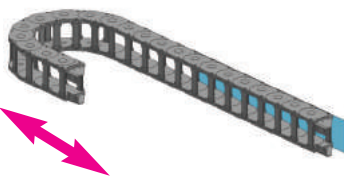

Horizontal application mounted on its side

» Calculation of the chain length

$$\left[L = \frac{L_s}{2} + L_p \right]$$

» Other installation length

Vertical curve above = max 7.0m
 Vertical curve below = max 150m
 Side Mounted, Unsupported = max 4.0m

» Load diagrams self-supporting length

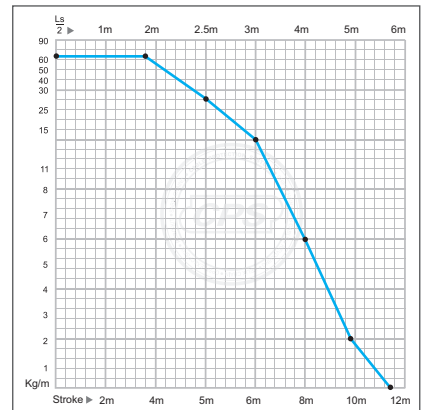

» Layout of the chain

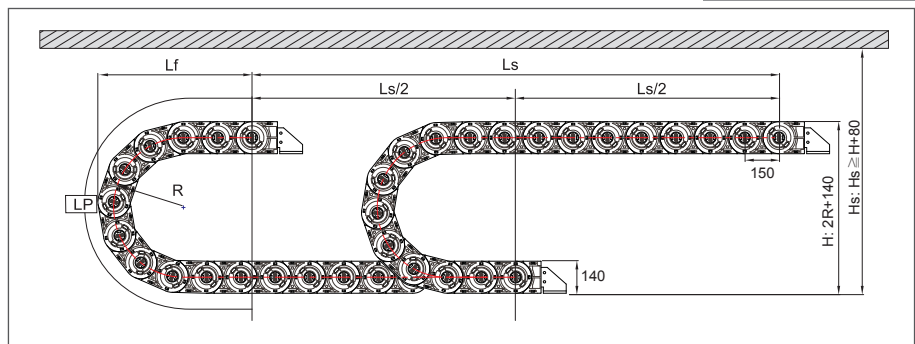

Bending Radius (R)	L _p Loop Length	L _f Loof Projection	H Moving Height
205	1,215	561	550
305	1,510	651	750
405	1,807	743	950
505	2,106	835	1,150
605	2,405	928	1,350

(Dimensions in mm)

» Chain cross section

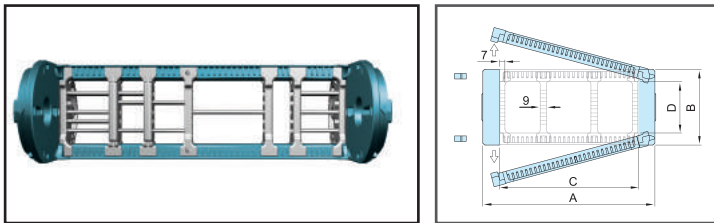

Chain Type	A Width (Outer)	B Height (Outer)	C Frame	D Height (Inner)	Weight kg/m
ST 150N	121	140	75	110	5.85
	146		100		5.96
	161		115		6.03
	171		125		6.08
	196		150		6.18
	221		175		6.30
	246		200		6.51
	286		240		6.72
	296		250		6.78
	336		290		7.06
	346		300		7.14
	396		350		7.51
	446		400		7.88
	496		450		8.18
	546		500		8.37
	596		550		9.11
646	600	9.26			

(Dimensions in mm)

» Free end bracket

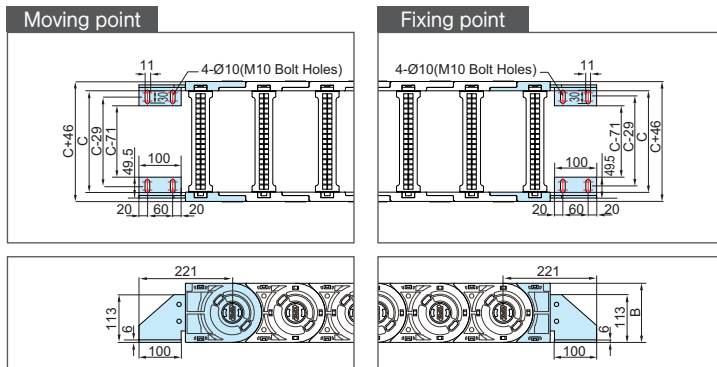

Chain Type	B Height(Outer)	C Frame	D Height(Inner)	Hole Type
ST 150N	140	75	110	M10 Bolt Holes
		100		
		115		
		125		
		150		
		175		
		200		
		240		
		250		
		290		
		300		
		350		
		400		
		450		
		500		
		550		
600				

(Dimensions in mm)

» Dividers(DV)

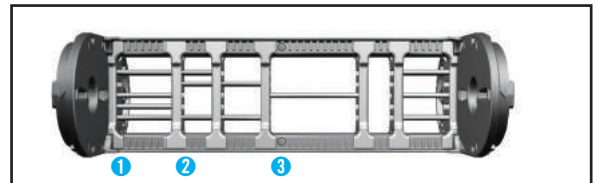

Assemble divider every second frame.

DV.M : Normal Divider.

DV.T : Applied to Frame 300~600.

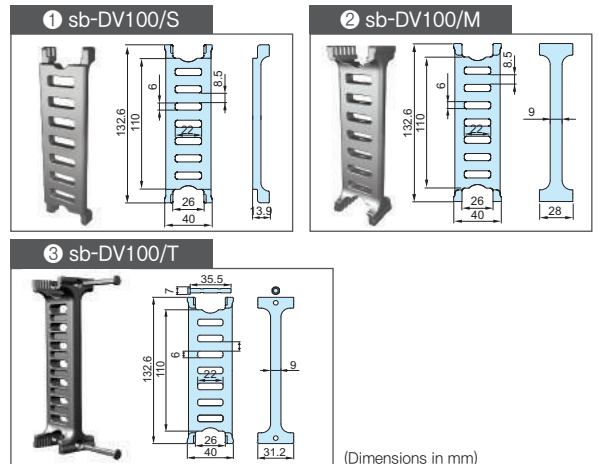

(Dimensions in mm)

» Separators(SP)

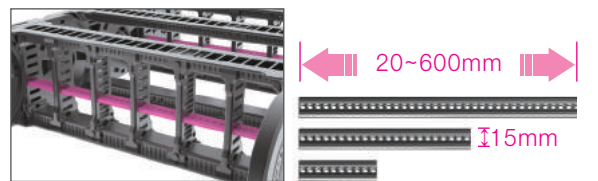

Chain Type	Ordering NO.
ST 150N	sb-SP/600,600

» Tie wrap (TW)

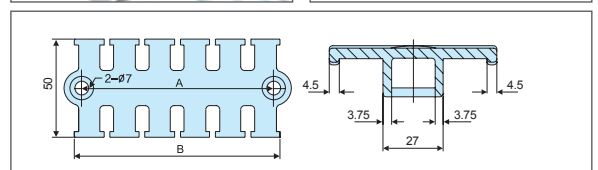
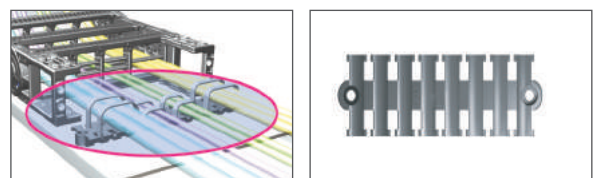

Chain Type	Ordering No.	A	B
ST 150N	S-TW50	58	65
	S-TW75	75	82
	S-TW100	98	105
	S-TW125	122	129
	S-TW150	141	148

(Dimensions in mm)

Shift Chain - Enclosed type



» General information

Item	Value
Material	CPS-Amid(PA6+GF), RoHs
Speed	3m/s
Acceleration	10m/s
Temperature	-30°C ~+130°C
Special production	ESD, UV
Certificate	CE, ATEX(Ex)

» Dimension table

Shift Chain E Type	Pitch	Bending Radius (R)	Weight kg/m	Speed m/s	Temperature °C	Size				Frame type	Section- composition
						A	B	C	D		
ST 044E	44	70, 90, 120, 150	1.03	3	-30 ~ +130	56	38	35	24.5		
			1.21			76		55			
			1.37			96		75			
			1.58			121		100			
ST 055E	55	100, 125, 150, 200	1.36	3	-30 ~ +130	71	52	50	38.5		
			1.56			96		75			
			1.76			121		100			
			1.97			146		125			
2.21	171	150									
ST 072E	72	120, 145, 200, 250, 300	2.37	3	-30 ~ +130	82	66	50	44		
			2.61			107		75			
			2.85			132		100			
			3.09			157		125			
3.33	172	150									
ST 095E	95	150, 200, 230, 280, 400	3.55	3	-30 ~ +130	138	82	100	55		
			3.79			163		125			
			4.04			188		150			
			4.29			213		175			
4.53	238	200									
ST 120E	120	200, 250, 300, 350, 400, 500	5.79	3	-30 ~ +130	192	108	150	76		
			6.43			242		200			
			7.07			292		250			
			7.71			342		290			
300	300	300									
ST 150E	150	305, 405, 505, 605	8.16	3	-30 ~ +130	246	141	200	110		
			8.76			296		250			
			10.50			346		300			
			12.33			396		350			
14.16	446	400									

(Dimensions in mm)

» Calculation table

Item	Value
Length of Cable Chain	$L = \frac{1}{2} \times LS + LP$
Bending Radius	
The biggest Cable inserted	Multiply 8~10 and the biggest cable
The biggest Hydraulic Hose inserted	Multiply 15~20 and the biggest hose

» Ordering

ST 044E, 100, R120 / F - 1500L : 10ST

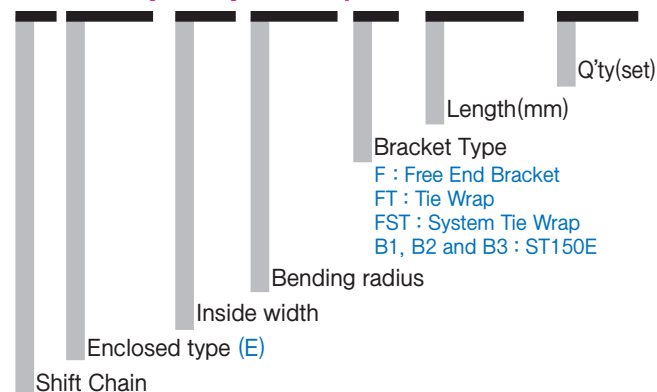

» Bracket type

- ST044, ST055, ST072, ST095, ST120

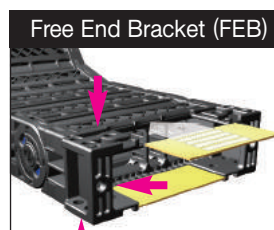

- ST150

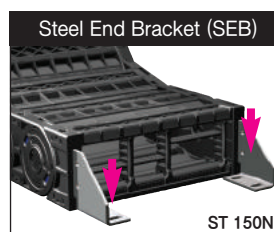

For ST150E, its end parts of cable chain being fixed are used with steel bracket, and it is possible to be installed B1, B2, B3 types of brackets.

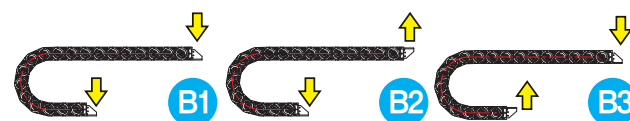

Shift Chain - Enclosed type

» Part of Shift Chain Enclosed type

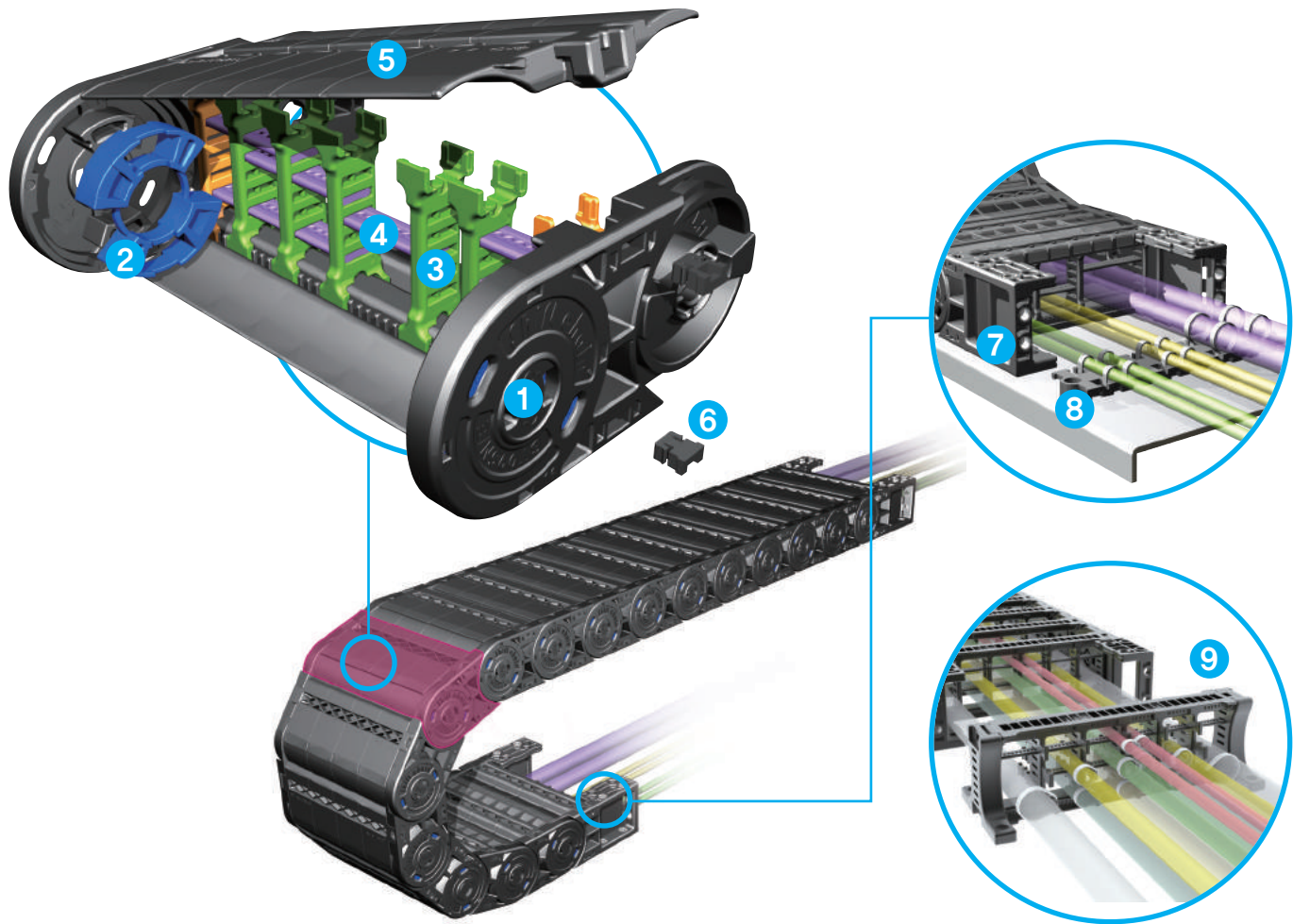

1 Side Band (SB)

A unit that connects each side band and between them BR is inserted to strengthen clamping force.

2 Bending Radius Unit (BR)

A unit that inserted between each side band. There are 6 supporting points to create durability.

3 Divider (DV-S, M, R, T)

A unit that divides inserted cables horizontally.

4 Separator (SP)

A unit that divides inserted cables vertically to prevent twisting and breaking problem.

5 FRU, FRD

A unit that connects left and right side band and there are 2 types of frame : FRU, FRD.

6 Frame Pin (FP)

The connecting pin for preventing the breakaway of Frame connected at Side Band, combining and fixing the Frame and Side Band. For Shift chain(ST)072E, 092E, 120E, 150E type, one side of the frame is fixed by inserting a fixing pin to prevent frame open, which caused by any external impact.

7 Free End Bracket (FEB)

A unit that connects at last side band (left&right). It can be fixed stronger using steel washers.

8 Tie Wrap (TW)

A unit that ties cables to maintain straightness of them. It can be assembled to bracket directly or installed separately from bracket.

9 System Tie Wrap (STW)

System-Tie Wrap has to be assembled on fixing and moving point of bracket and can be assembled without any tie wrap plate. This tie wrap is used to stay the cables on several floors prevent the cables from being twisted and it can also be assemble without any tools or bolt. This tie wrap has two types, one is to assemble inside bracket the other one is outside.

» Assemble procedure of Shift Chain Enclosed type

The assembling process of Shift Chain E-Type is like below and you must use rubber hammer with careful combination of Divider and Separator. Be careful of different assembling process depending on product specification such as ST044E, 055E Type, ST072E, 095E, 120E Type, ST150E Type etc.

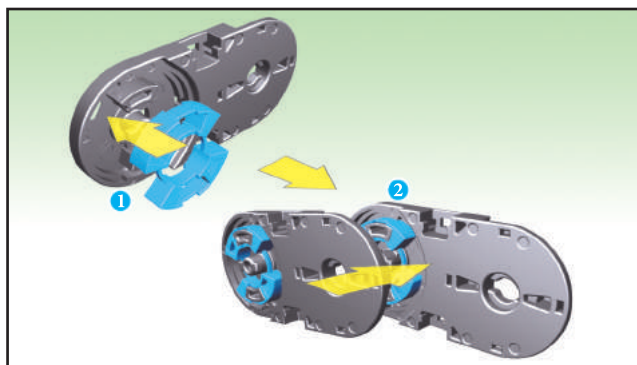

1 Insert BR unit to each side band, connect the side bands as many as you need, then do the same process to the other side of side band.

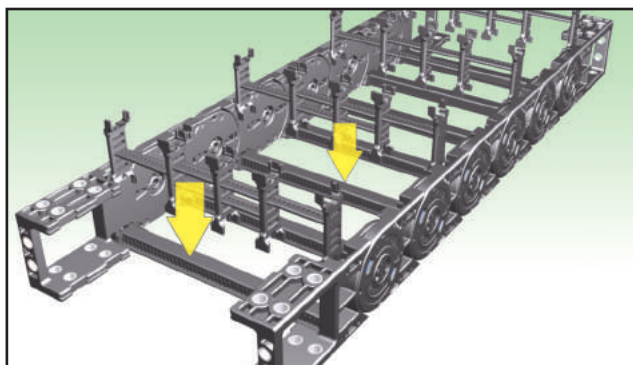

5 Fix the separator and divider patterns to the bottom-side frames as needed.

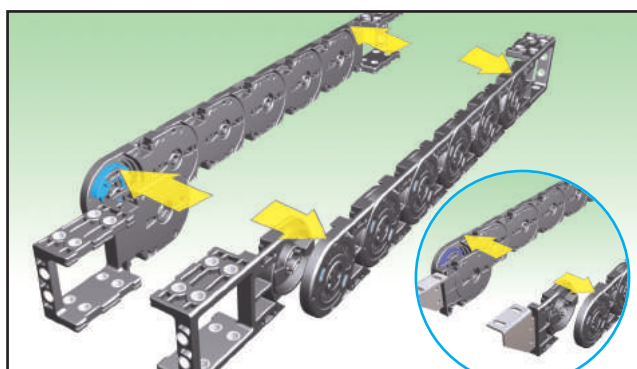

2 Assemble the end brackets on both ends using the same method. For ST150E, assemble steel brackets on both ends.

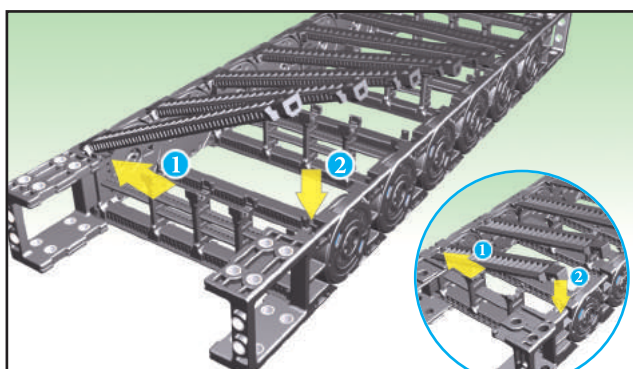

6 Attach frames to one side groove on the side band, and then the other side. ST044E, 055E frame type.

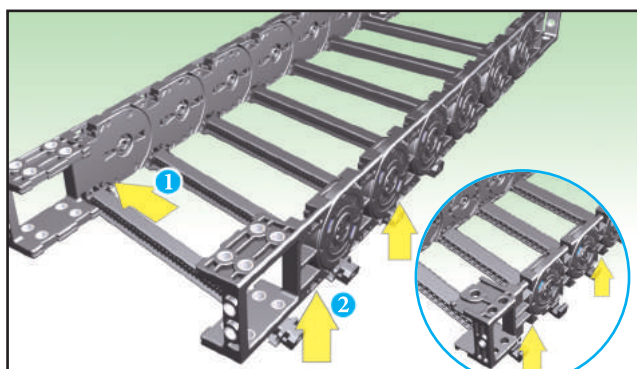

3 Attach frames to one side groove on the side band, and then the other side. ST 044E, 055E are Hinge Type or Hook Type without frame pin.

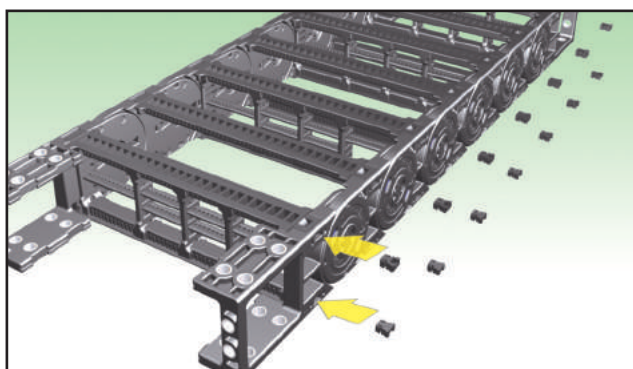

7 Insert frame pins to secure the frames and complete carrier. (ST072E, 095E, 120E, 150E are applied with frame pin, and ST044E, 055E are Hinge Type or Hook Type without frame pin.)

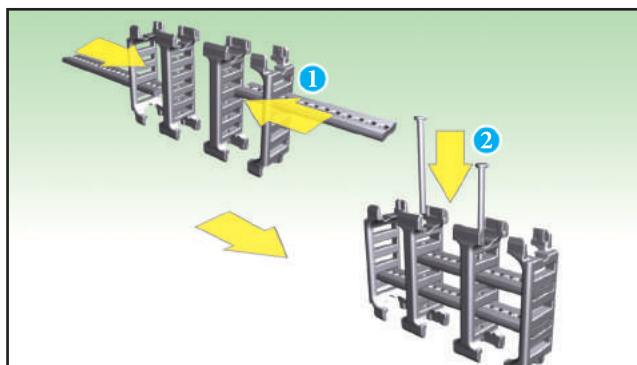

4 For ST072E, 095E, 120E, and 150E, connect the pin of separator in hole of divider after inserting separator in hole of divider. For ST044E and ST055E, separator fixing pins are not used.

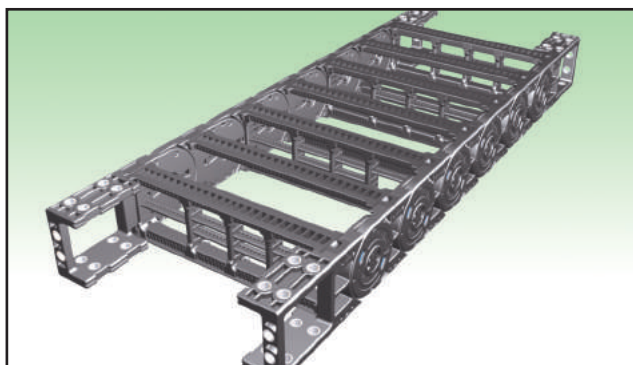

8 Assembled Shift Chain E-Type is assembled.

Shift Chain - Enclosed type

» Part list of Shift Chain Enclosed type

- Composition of Cable chain(Standard)
= Side band(RH) + Frame + Side band(LH) + Bending radius Unit + Free end bracket
- M divider(normal divider) should be applied every second frames to make a section composition.
- ※ Please refer to below part list and description to understand composition of cable chain.

Model	Classification	Part number	Description
ST044E	SIDE BAND	ST-SB044N/E(LH) ST-SB044N/E(RH)	Left side band of ST044E Right side band of ST044E
	BENDING RADIUS	ST-BR044,R70,90,120,150	Bending radius unit for side band
	FRAME(DOWN) FRAME(UP)	ST-FRD044,35 ST-FRU044,35 ST-FRD044,55 ST-FRU044,55 ST-FRD044,75 ST-FRU044,75 ST-FRD044,100 ST-FRU044,100	Inside frame, 35mm Outside frame, 35mm Inside frame, 55mm Outside frame, 55mm Inside frame, 75mm Outside frame, 75mm Inside frame, 100mm Outside frame, 100mm
	FRAME(DOWN-FIXING END) FRAME(UP-FIXING END) FRAME(DOWN-MOVING END) FRAME(UP-MOVING END)	ST-FRD044,100 ST-FRU044,100 ST-FRDFE044,35,55,75,100 ST-FRUF044,35,55,75,100 ST-FRDME044,35,55,75,100 ST-FRUME044,35,55,75,100	Inside half-frame for fixing end bracket Outside half-frame for fixing end bracket Inside half-frame for moving end bracket Outside half-frame for moving end bracket
	FREE END BRACKET	ST-FEB044E	End bracket of ST044E
	DIVIDER	sb-DV028/M sb-DV028/S	Normal divider To fix separstors at the both side section
	SEPARATOR	S-SP/M,35 S-SP/M,50 S-SP/M,75 S-SP/M,100	Separator, 35mm Separator, 50mm Separator, 75mm Separator, 100mm
	TIE WRAP	S-TW036/025CR,35 S-TW036/025CR,55 S-TW036/025CR,75 S-TW036/025CR,100 S-TW036/025CR,125	Tie wrap for end bracket to fix cables, 35mm Tie wrap for end bracket to fix cables, 55mm Tie wrap for end bracket to fix cables, 75mm Tie wrap for end bracket to fix cables, 100mm Tie wrap for end bracket to fix cables, 125mm
	SYSTEM TIE WRAP	sb-DV028/W S-TW,EB028	Divider for fixing cables at end bracket System tie wrap to arrange for cables right after moving bracket or fixing bracket

Model	Classification	Part number	Description
ST055E	SIDE BAND	ST-SB055N/E(LH) ST-SB055N/E(RH)	Left side band of ST055E Right side band of ST055E
	BENDING RADIUS	ST-BR055,R100,125,150,200	Bending radius unit for side band
	FRAME(DOWN) FRAME(UP)	ST-FRD055,50 ST-FRU055,50 ST-FRD055,75 ST-FRU055,75 ST-FRD055,100 ST-FRU055,100 ST-FRD055,125 ST-FRU055,125 ST-FRD055,150 ST-FRU055,150	Inside frame, 50mm Outside frame, 50mm Inside frame, 75mm Outside frame, 75mm Inside frame, 100mm Outside frame, 100mm Inside frame, 125mm Outside frame, 125mm Inside frame, 150mm Outside frame, 150mm
	FRAME(DOWN-FIXING END) FRAME(UP-FIXING END) FRAME(DOWN-MOVING END) FRAME(UP-MOVING END)	ST-FRD055,150 ST-FRU055,150 ST-FRDFE055,75,100,125,150 ST-FRUF055,75,100,125,150 ST-FRDME055,75,100,125,150 ST-FRUME055,75,100,125,150	Inside half-frame for fixing end bracket Outside half-frame for fixing end bracket Inside half-frame for moving end bracket Outside half-frame for moving end bracket
	FREE END BRACKET	ST-FEB055E	End bracket of ST055E
	DIVIDER	sb-DV035/M sb-DV035/S	Normal divider To fix separstors at the both side section
	SEPARATOR	S-SP/M,35 S-SP/M,50 S-SP/M,75 S-SP/M,100 S-SP/M,125 S-SP/M,150	Separator, 35mm Separator, 50mm Separator, 75mm Separator, 100mm Separator, 125mm Separator, 150mm
	TIE WRAP	S-TW036/025CR,50 S-TW036/025CR,75 S-TW036/025CR,100 S-TW036/025CR,125 S-TW036/025CR,150 S-TW036/025CR,175 S-TW036/025CR,200	Tie wrap for end bracket to fix cables, 50mm Tie wrap for end bracket to fix cables, 75mm Tie wrap for end bracket to fix cables, 100mm Tie wrap for end bracket to fix cables, 125mm Tie wrap for end bracket to fix cables, 150mm Tie wrap for end bracket to fix cables, 175mm Tie wrap for end bracket to fix cables, 200mm
	SYSTEM TIE WRAP	sb-DV035/W S-TW,EB035	Divider for fixing cables at end bracket System tie wrap to arrange for cables right after moving bracket or fixing bracket

Model	Classification	Part number	Description
ST072E	SIDE BAND	ST-SB072N/E(LH) ST-SB072N/E(RH)	Left side band of ST072E Right side band of ST072E
	BENDING RADIUS	ST-BR072, R120,145,200,250,300	Bending radius unit for side band
	FRAME PIN	S-FP/S1	Frame pin
	FRAME(DOWN) FRAME(UP)	ST-FRD072,50 ST-FRU072,50 ST-FRD072,75 ST-FRU072,75 ST-FRD072,100 ST-FRU072,100 ST-FRD072,125 ST-FRU072,125 ST-FRD072,150 ST-FRU072,150	Inside frame, 50mm Outside frame, 50mm Inside frame, 75mm Outside frame, 75mm Inside frame, 100mm Outside frame, 100mm Inside frame, 125mm Outside frame, 125mm Inside frame, 150mm Outside frame, 150mm
	FRAME(DOWN-FIXING END) FRAME(UP-FIXING END) FRAME(DOWN-MOVING END) FRAME(UP-MOVING END)	ST-FRD072,150 ST-FRU072,150 ST-FRDFE072,50,75,100,125,150 ST-FRUF072,50,75,100,125,150 ST-FRDME072,50,75,100,125,150 ST-FRUME072,50,75,100,125,150	Inside half-frame for fixing end bracket Outside half-frame for fixing end bracket Inside half-frame for moving end bracket Outside half-frame for moving end bracket
	FREE END BRACKET	ST-FEB072E sb-FEB/WH045	End bracket of ST072E Steel washer for end bracket
	DIVIDER	sb-DV045/M sb-DV045/S	Normal divider To fix separstors at the both side section
	SEPARATOR	sb-SP/400,400 SP-PIN045	Separator, 400mm Separator pin to fix
	TIE WRAP	S-TW50 S-TW75 S-TW100 S-TW125 S-TW150	Tie wrap for end bracket to fix cables, 50mm Tie wrap for end bracket to fix cables, 75mm Tie wrap for end bracket to fix cables, 100mm Tie wrap for end bracket to fix cables, 125mm Tie wrap for end bracket to fix cables, 150mm
	SYSTEM TIE WRAP	sb-DV045/W S-TW,EB045	Divider for fixing cables at end bracket System tie wrap to arrange for cables right after moving bracket or fixing bracket

Model	Classification	Part number	Description
ST095E	SIDE BAND	ST-SB095N/E(LH) ST-SB095N/E(RH)	Left side band of ST095N Right side band of ST095N
	BENDING RADIUS	ST-BR095.R150,200,230,280,400	Bending radius unit for side band
	FRAME PIN	S-FP/S1	FRAME PIN
	FRAME(DOWN) FRAME(UP)	ST-FRD095.100 ST-FRU095.100 ST-FRD095.125 ST-FRU095.125 ST-FRD095.150 ST-FRU095.150 ST-FRD095.175 ST-FRU095.175 ST-FRD095.200 ST-FRU095.200	Inside frame, 100mm Outside frame, 100mm Inside frame, 125mm Outside frame, 125mm Inside frame, 150mm Outside frame, 150mm Inside frame, 175mm Outside frame, 175mm Inside frame, 200mm Outside frame, 200mm
	FRAME(DOWN-FIXING END) FRAME(UP-FIXING END) FRAME(DOWN-MOVING END) FRAME(UP-MOVING END)	ST-FRD095.100,125,150,175,200 ST-FRU095.100,125,150,175,200 ST-FRDME095.100,125,150,175,200 ST-FRUME095.100,125,150,175,200	Inside half-frame for fixing end bracket Outside half-frame for fixing end bracket Inside half-frame for moving end bracket Outside half-frame for moving end bracket
	FREE END BRACKET	ST-FEB095E sb-FEB/WH060	End bracket of ST095E Steel washer for end bracket
	DIVIDER	sb-DV060/M sb-DV060/S	Normal divider To fix separstors at the both side section
	SEPARATOR	sb-SP/400.400 SP-PIN060	Separator, 400mm Separator pin to fix
	TIE WRAP	S-TW50 S-TW75 S-TW100 S-TW125 S-TW150	Tie wrap for end bracket to fix cables, 50mm Tie wrap for end bracket to fix cables, 75mm Tie wrap for end bracket to fix cables, 100mm Tie wrap for end bracket to fix cables, 125mm Tie wrap for end bracket to fix cables, 150mm
	SYSTEM TIE WRAP	sb-DV060/W S-TW,EB060	Divider for fixing cables at end bracket System tie wrap to arrange for cables right after moving bracket or fixing bracket

Model	Classification	Part number	Description
ST120E	SIDE BAND	ST-SB120N/E(LH) ST-SB120N/E(RH)	Left side band of ST120N Right side band of ST120N
	BENDING RADIUS	ST-BR120.R200,250,300,350,400,500	Bending radius unit for side band
	FRAME PIN	S-FP/S2	FRAME PIN
	FRAME(DOWN) FRAME(UP)	ST-FRD120.150 ST-FRU120.150 ST-FRD120.200 ST-FRU120.200 ST-FRD120.250 ST-FRU120.250 ST-FRD120.300 ST-FRU120.300	Inside frame, 150mm Outside frame, 150mm Inside frame, 200mm Outside frame, 200mm Inside frame, 250mm Outside frame, 250mm Inside frame, 300mm Outside frame, 300mm
	FRAME(DOWN-FIXING END) FRAME(UP-FIXING END) FRAME(DOWN-MOVING END) FRAME(UP-MOVING END)	ST-FRD120.150,200,250,300 ST-FRU120.150,200,250,300 ST-FRDME120.150,200,250,300 ST-FRUME120.150,200,250,300	Inside half-frame for fixing end bracket Outside half-frame for fixing end bracket Inside half-frame for moving end bracket Outside half-frame for moving end bracket
	FREE END BRACKET	ST-FEB120E sb-FEB/WH075	End bracket of ST120E Steel washer for end bracket
	DIVIDER	sb-DV075/M sb-DV075/S	Normal divider To fix separstors at the both side section
	SEPARATOR	sb-SP/400.400 SP-PIN075	Separator, 400mm Separator pin to fix
	TIE WRAP	S-TW50 S-TW75 S-TW100 S-TW125 S-TW150	Tie wrap for end bracket to fix cables, 50mm Tie wrap for end bracket to fix cables, 75mm Tie wrap for end bracket to fix cables, 100mm Tie wrap for end bracket to fix cables, 125mm Tie wrap for end bracket to fix cables, 150mm
	SYSTEM TIE WRAP	sb-DV075/W S-TW,EB075	Divider for fixing cables at end bracket System tie wrap to arrange for cables right after moving bracket or fixing bracket

Model	Classification	Part number	Description
ST150E	SIDE BAND	ST-SB150N/E(LH) ST-SB150N/E(RH)	Left side band of ST120N Right side band of ST120N
	BENDING RADIUS	ST-BR150.R305,405,505,605	Bending radius unit for side band
	FRAME PIN	S-FP/S2	FRAME PIN
	FRAME(DOWN) FRAME(UP)	ST-FRD150.200 ST-FRU150.200 ST-FRD150.250 ST-FRU150.250 ST-FRD150.300 ST-FRU150.300 ST-FRD150.350 ST-FRU150.350 ST-FRD150.400 ST-FRU150.400	Inside frame, 200mm Outside frame, 200mm Inside frame, 250mm Outside frame, 250mm Inside frame, 300mm Outside frame, 300mm Inside frame, 350mm Outside frame, 350mm Inside frame, 400mm Outside frame, 400mm
	FRAME(DOWN-FIXING END) FRAME(UP-FIXING END) FRAME(DOWN-MOVING END) FRAME(UP-MOVING END)	ST-FRD150.200,250,300,350,400 ST-FRU150.200,250,300,350,400 ST-FRDME150.200,250,300,350,400 ST-FRUME150.200,250,300,350,400	Inside half-frame for fixing end bracket Outside half-frame for fixing end bracket Inside half-frame for moving end bracket Outside half-frame for moving end bracket
	STEEL END BRACKET	ST-SEB150E/B1~B2~B3	Steel end bracket of ST150E
	DIVIDER DIVIDER(SIDE)	sb-DV100/M sb-DV100/S	Normal divider To fix separstors at the both side section
	SEPARATOR	sb-SP/600.600 SP-PIN100	Separator, 600mm Separator pin to fix
	TIE WRAP	S-TW50 S-TW75 S-TW100 S-TW125 S-TW150	Tie wrap for end bracket to fix cables, 50mm Tie wrap for end bracket to fix cables, 75mm Tie wrap for end bracket to fix cables, 100mm Tie wrap for end bracket to fix cables, 125mm Tie wrap for end bracket to fix cables, 150mm

ST 044E

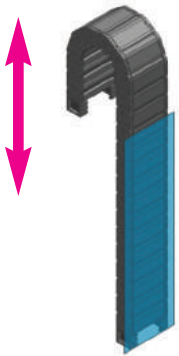
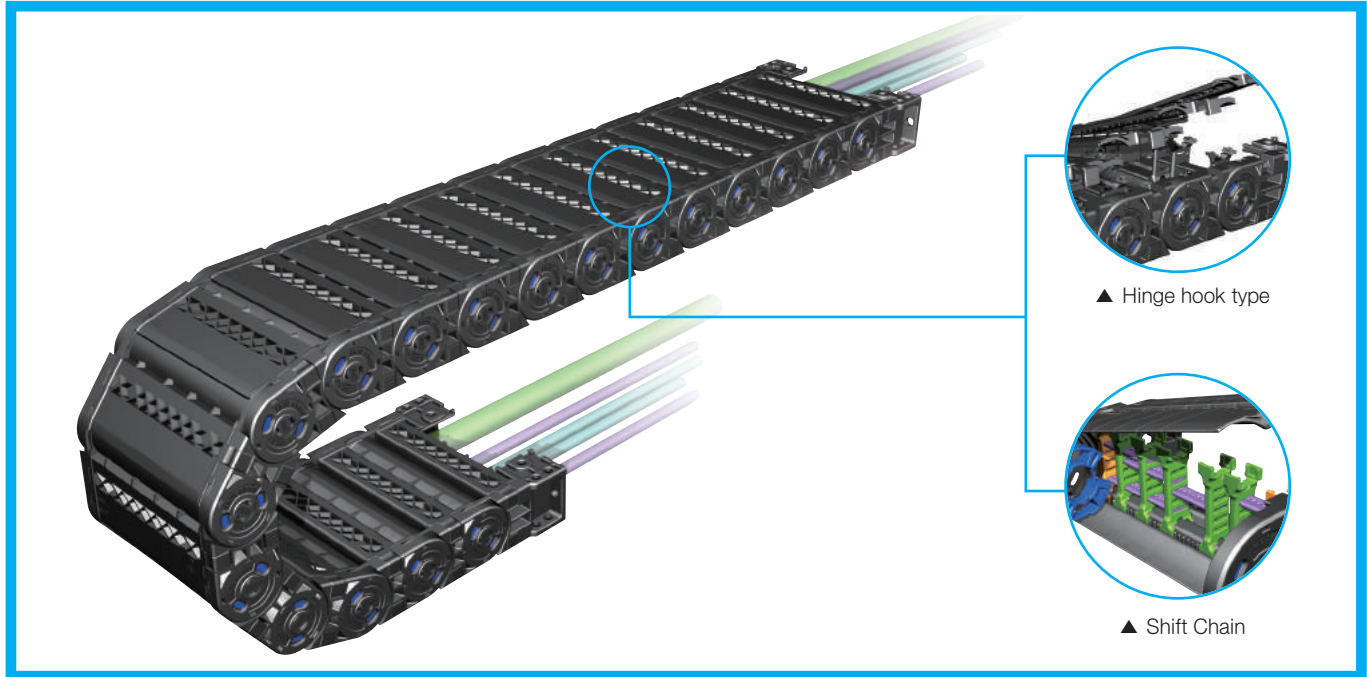

Vertical with curve above

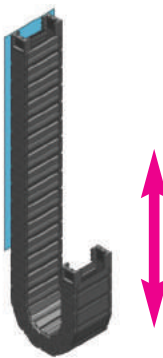

Vertical with curve below

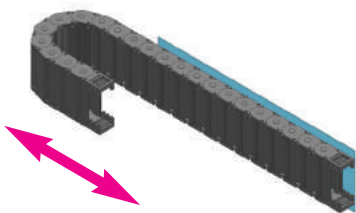

Horizontal application mounted on its side

» Calculation of the chain length

$$\left[L = \frac{L_s}{2} + L_p \right]$$

» Other installation length

Vertical curve above = max 2.0m
 Vertical curve below = max 40m
 Side Mounted, Unsupported = max 1.0m

» Load diagrams self-supporting length

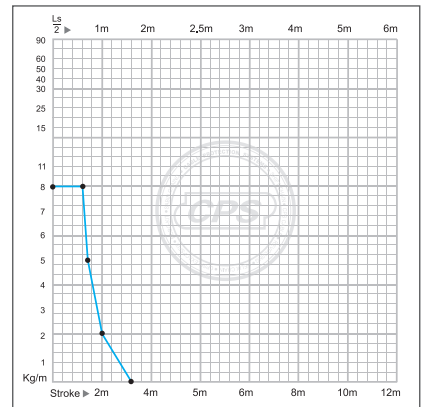

» Layout of the chain

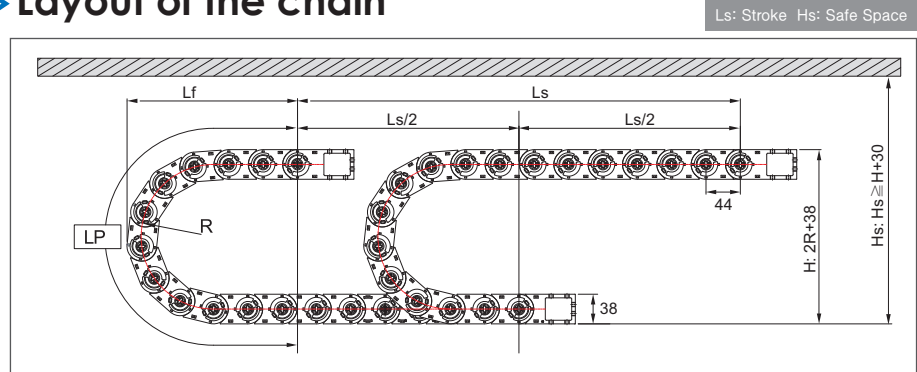

Bending Radius (R)	L_p Loop Length	L_f Loof Projection	H Moving Height
70	396	177	178
90	459	197	218
120	553	227	278
150	648	257	338

(Dimensions in mm)

» Chain cross section

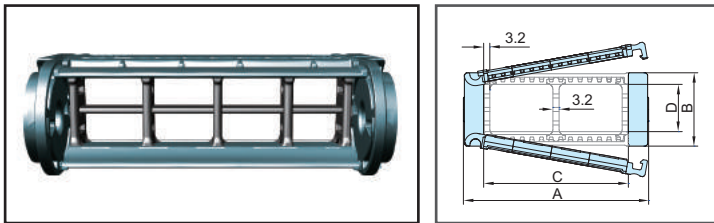

Chain Type	A Width (Outer)	B Height (Outer)	C Frame	D Height (Inner)	Weight kg/m
ST 044E	56	38	35	24.5	1.03
	76		55		1.21
	96		75		1.37
	121		100		1.58

(Dimensions in mm)

» Dividers(DV)

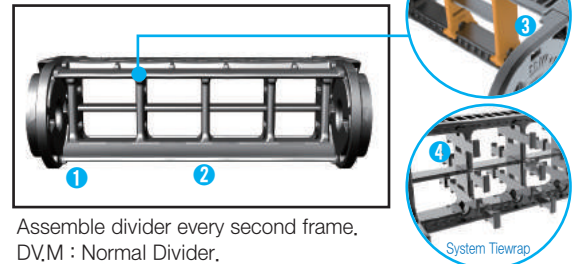

Assemble divider every second frame.

DV.M : Normal Divider.

DV.W : Tie wrap divider for free end bracket(FEB).

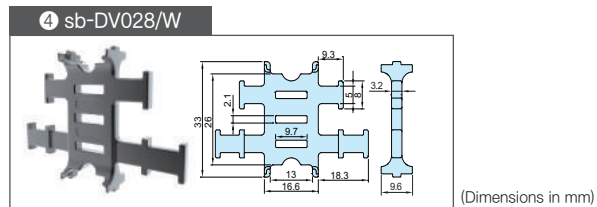
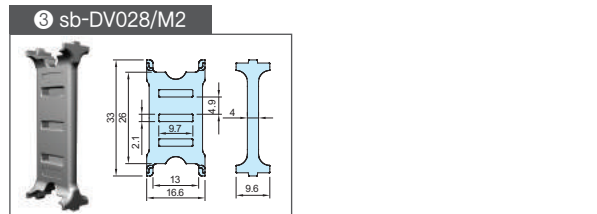
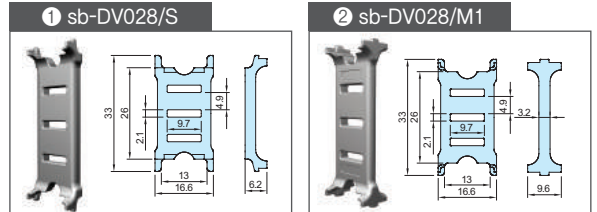

(Dimensions in mm)

» Free end bracket

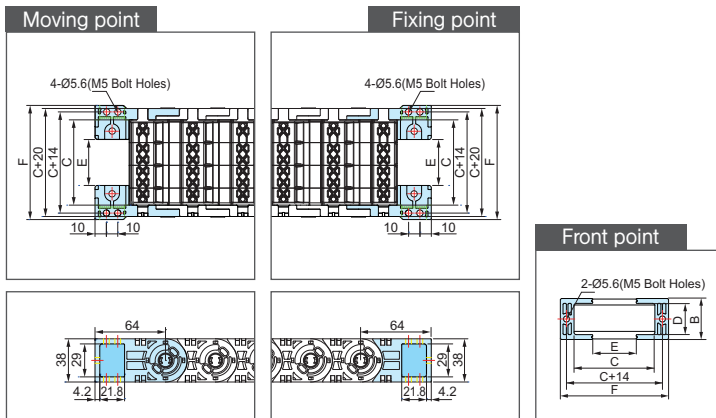

Chain Type	F Width(Outer)	B Height(Outer)	C Frame	D Height(Inner)	E M,EB Bolt hole width	Hole Type
ST 044E	60.4	38	35	24.5	0.4	M5 Bolt Holes
	80.4		55		20.4	
	100.4		75		40.4	
	125.4		100		65.4	

(Dimensions in mm)

» Separators(SP)

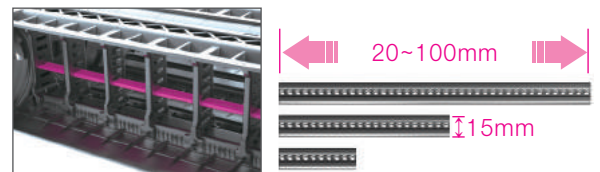

Chain Type	Ordering NO.	Frame
ST 044E	S-SP/M,35	35
	S-SP/M,55	55
	S-SP/M,75	75
	S-SP/M,100	100

» System tie wrap (STW)

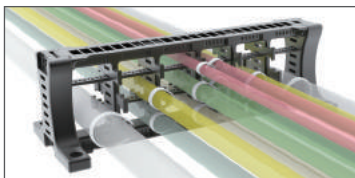

It is a unit to classify each cable for preventing entanglement of cables. It can either be installed to free end bracket or installed separately according its application environment.

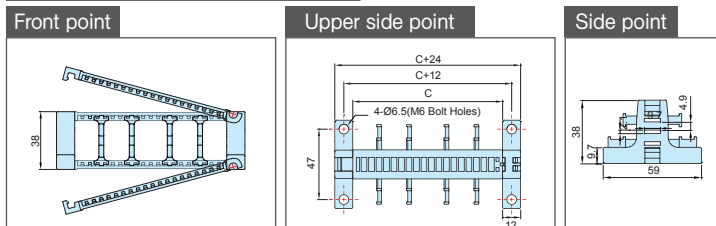

Chain Type	Ordering No.	C Frame	Hole Type
ST 044E	S-TW,EB028,35	35	M6 Bolt Holes
	S-TW,EB028,55	55	
	S-TW,EB028,75	75	
	S-TW,EB028,100	100	

(Dimensions in mm)

» Tie wrap (TW)

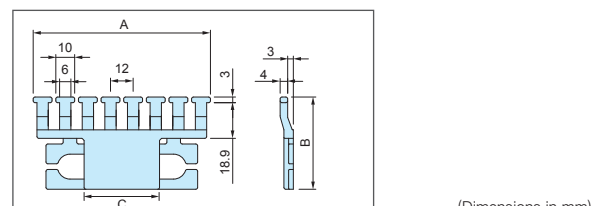
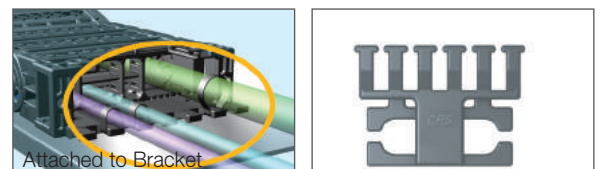

(Dimensions in mm)

Chain Type	Ordering No.	A	B	C
ST 044E	S-TW036/025CR,35	46	35.4	-
	S-TW036/025CR,55	70	48.9	20
	S-TW036/025CR,75	94	48.9	40
	S-TW036/025CR,100	118	48.9	65

ST 055E

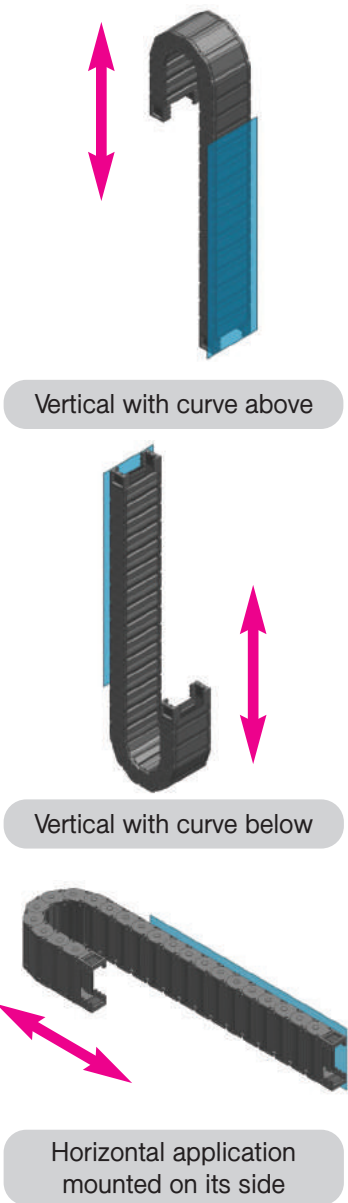
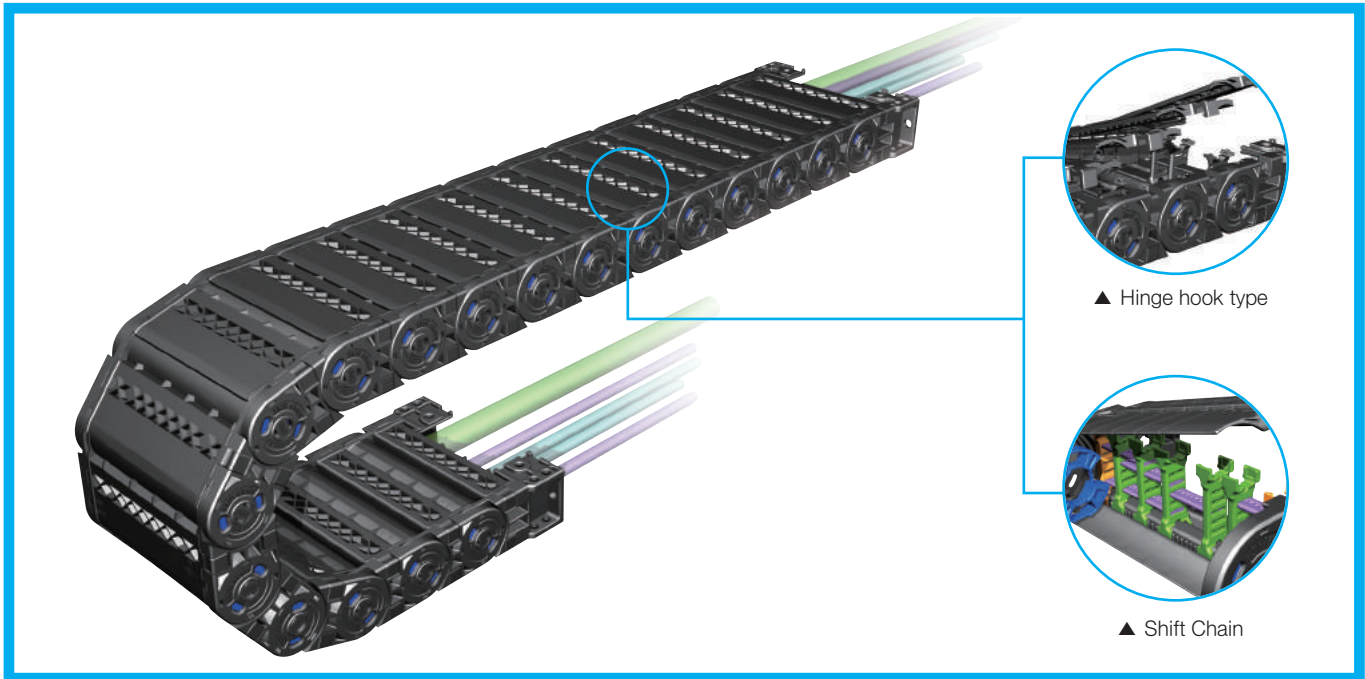

» Calculation of the chain length

$$\left[L = \frac{L_s}{2} + L_p \right]$$

» Other installation length

Vertical curve above = max 3.0m
 Vertical curve below = max 50m
 Side Mounted, Unsupported = max 1.0m

» Load diagrams self-supporting length

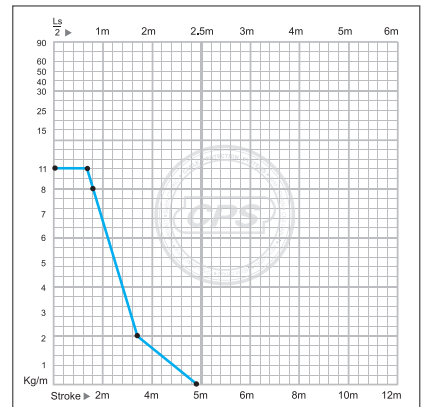

» Layout of the chain

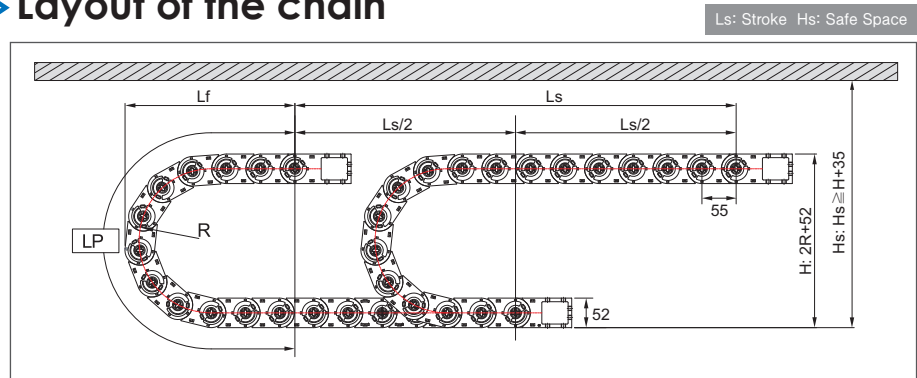

Bending Radius (R)	Lp Loop Length	Lf Loof Projection	H Moving Height
100	535	236	252
125	613	261	302
150	692	286	352
200	849	336	452

(Dimensions in mm)

» Chain cross section

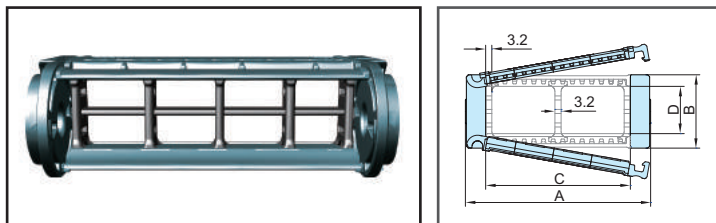

Chain Type	A Width (Outer)	B Height (Outer)	C Frame	D Height (Inner)	Weight kg/m
ST 055E	71	52	50	38.5	1.36
	96		75		1.56
	121		100		1.76
	146		125		1.97
	171		150		2.21

(Dimensions in mm)

» Free end bracket

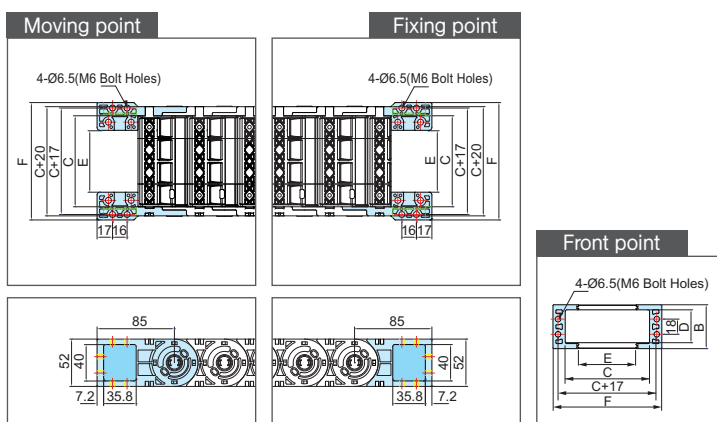

Chain Type	F Width(Outer)	B Height(Outer)	C Frame	D Height(Inner)	E M,EB Bolt hole width	Hole Type
ST 055E	79	52	50	38.5	18	M6 Bolt Holes
	104		75		43	
	129		100		68	
	154		125		93	
	179		150		118	

(Dimensions in mm)

» System tie wrap (STW)

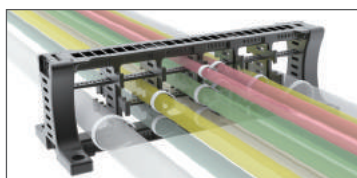

It is a unit to classify each cable for preventing entanglement of cables. It can either be installed to free end bracket or installed separately according its application environment.

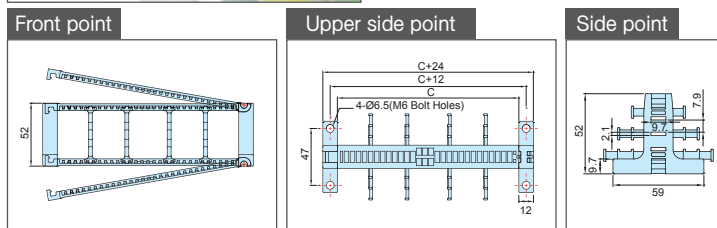

Chain Type	Ordering No.	C Frame	Hole Type
ST 055E	S-TW,EB035,50	50	M6 Bolt Holes
	S-TW,EB035,75	75	
	S-TW,EB035,100	100	
	S-TW,EB035,125	125	
	S-TW,EB035,150	150	

(Dimensions in mm)

» Dividers(DV)

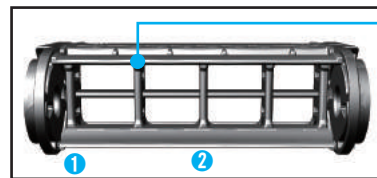

Assemble divider every second frame.
DV.M : Normal Divider.
DV.W : Tie wrap divider for free end bracket(FEB).

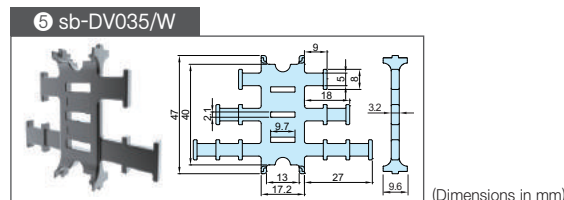
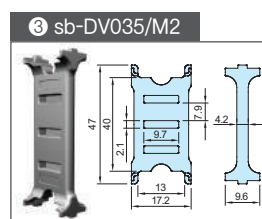
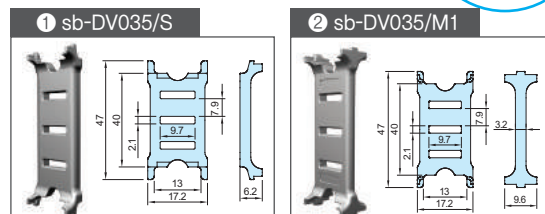

(Dimensions in mm)

» Separators(SP)

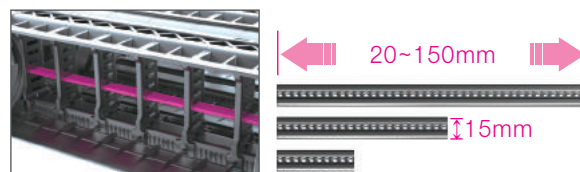

Chain Type	Ordering NO.	Frame
ST 055E	S-SP/M,50	50
	S-SP/M,75	75
	S-SP/M,100	100
	S-SP/M,125	125
	S-SP/M,150	150

» Tie wrap (TW)

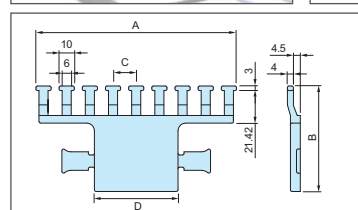
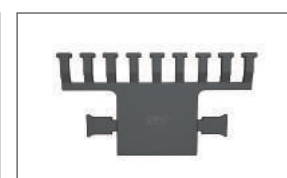
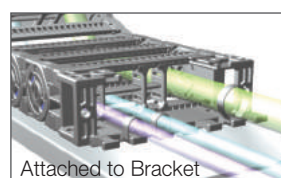

Chain Type	Ordering No.	A	B	C	D
ST 055E	S-TW050/035N,50	82	64.5	12.00	5
	S-TW050/035N,75	107		12.13	30
	S-TW050/035N,100	132		15.25	55
	S-TW050/035N,125	157		14.70	80
	S-TW050/035N,150	182		14.35	105

(Dimensions in mm)

ST 072E

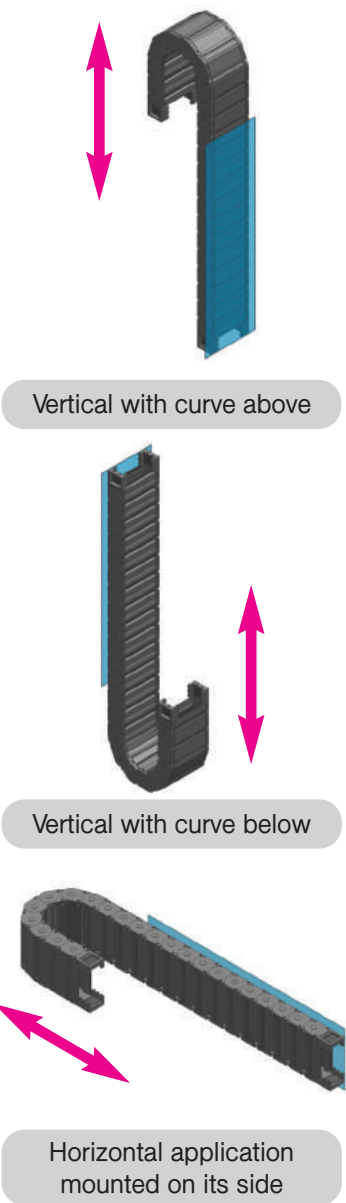
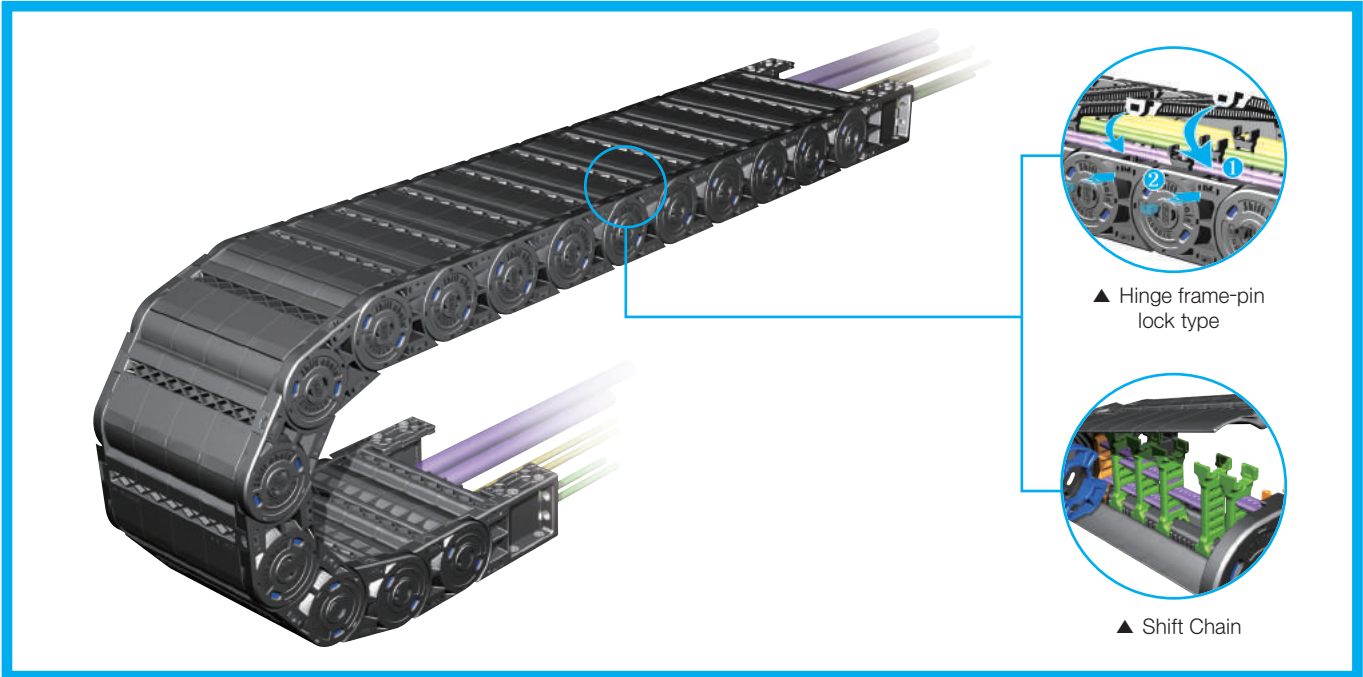

» Calculation of the chain length

$$\left[L = \frac{L_s}{2} + L_p \right]$$

» Other installation length

Vertical curve above = max 6.0m
 Vertical curve below = max 100m
 Side Mounted, Unsupported = max 2.5m

» Load diagrams self-supporting length

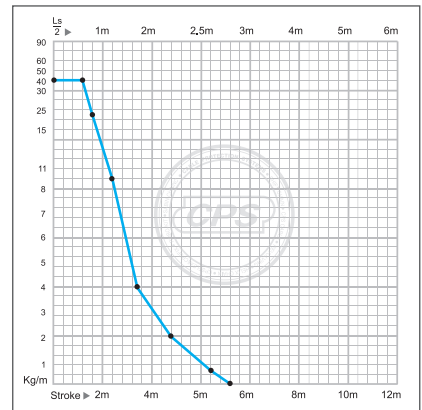

» Layout of the chain

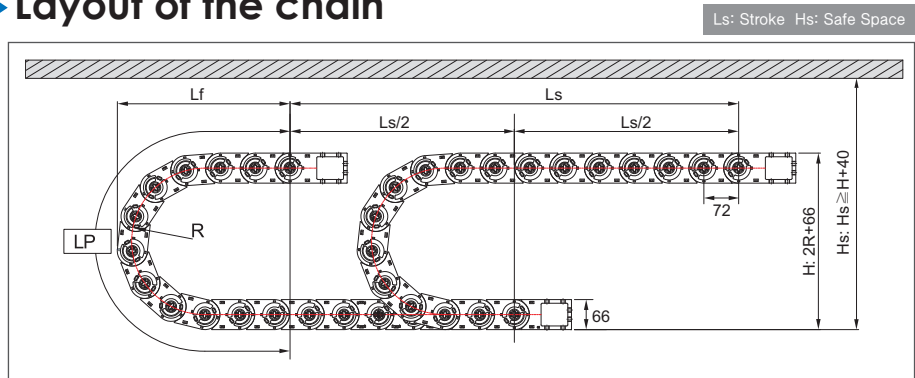

Bending Radius (R)	Lp Loop Length	Lf Loof Projection	H Moving Height
120	665	297	306
145	743	322	356
200	916	377	466
250	1,074	427	566
300	1,230	477	666

(Dimensions in mm)

» Chain cross section

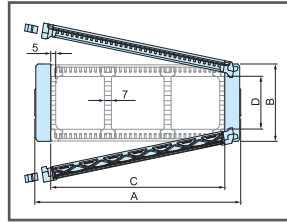
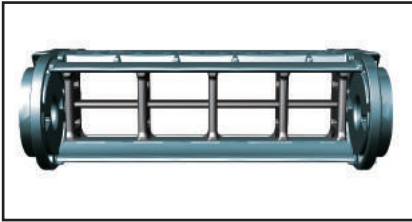

Chain Type	A Width (Outer)	B Height (Outer)	C Frame	D Height (Inner)	Weight kg/m
ST 072E	82	66	50	44	2.37
	107		75		2.61
	132		100		2.85
	157		125		3.09
	182		150		3.33

(Dimensions in mm)

» Dividers(DV)

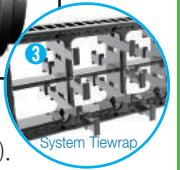
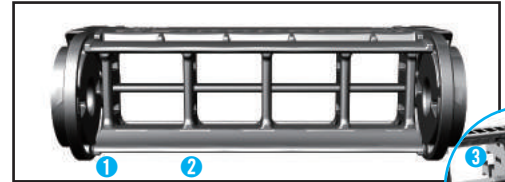

Assemble divider every second frame.
 DV.M : Normal Divider.
 DV.W : Tie wrap divider for free end bracket (FEB).

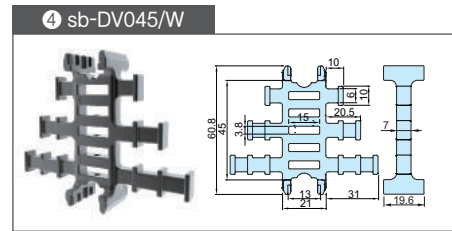
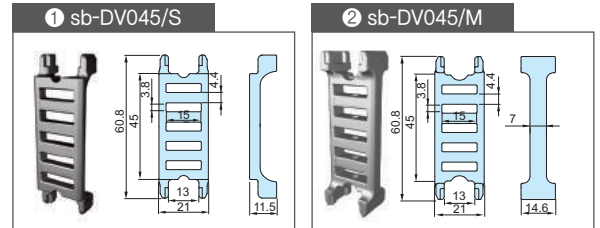

(Dimensions in mm)

» Free end bracket

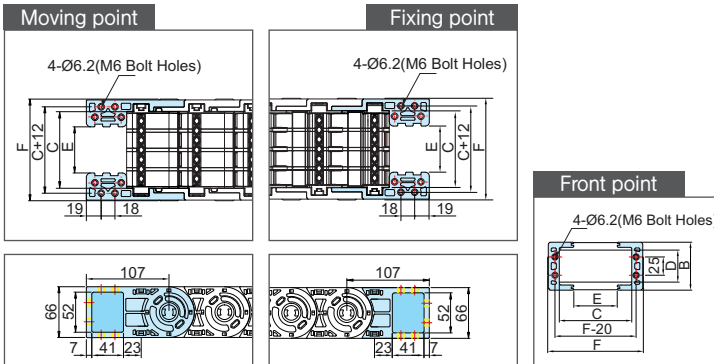

Chain Type	A Width(Outer)	B Height(Outer)	C Frame	D Height(Inner)	E M,EB Bolt hole width	Hole Type
ST 072E	82	66	50	44	10	M6 Bolt Holes
	107		35			
	132		60			
	157		85			
	182		110			

(Dimensions in mm)

» Separators(SP)

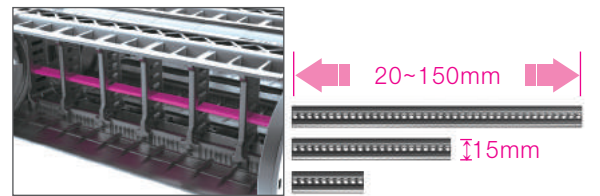

Chain Type	Ordering NO.
ST 072E	sb-SP/400,400

» System tie wrap (STW)

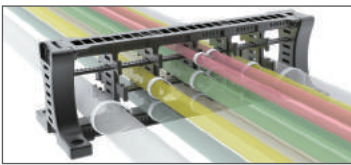

It is a unit to classify each cable for preventing entanglement of cables. It can either be installed to free end bracket or installed separately according its application environment.

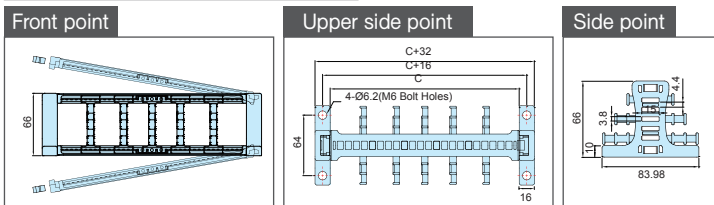

Chain Type	Ordering No.	C Frame	Hole Type
ST 072E	S-TWEB045.50	50	M6 Bolt Holes
	S-TWEB045.75	75	
	S-TWEB045.100	100	
	S-TWEB045.125	125	
	S-TWEB045.150	150	

(Dimensions in mm)

» Tie wrap (TW)

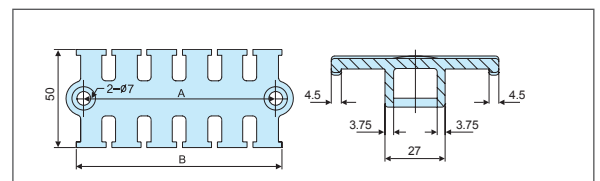
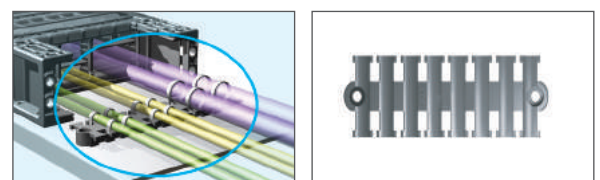

Chain Type	Ordering No.	A	B
ST 072E	S-TW50	58	65
	S-TW75	75	82
	S-TW100	98	105
	S-TW125	122	129
	S-TW150	141	148

(Dimensions in mm)

ST 095E

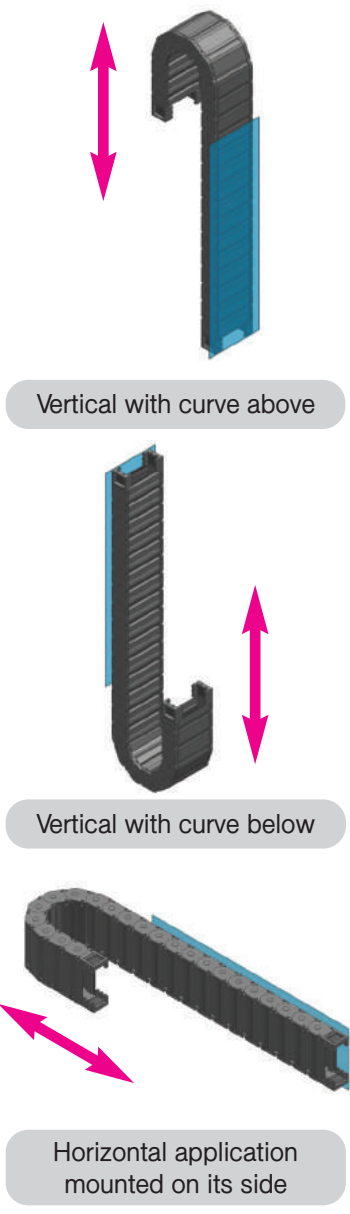
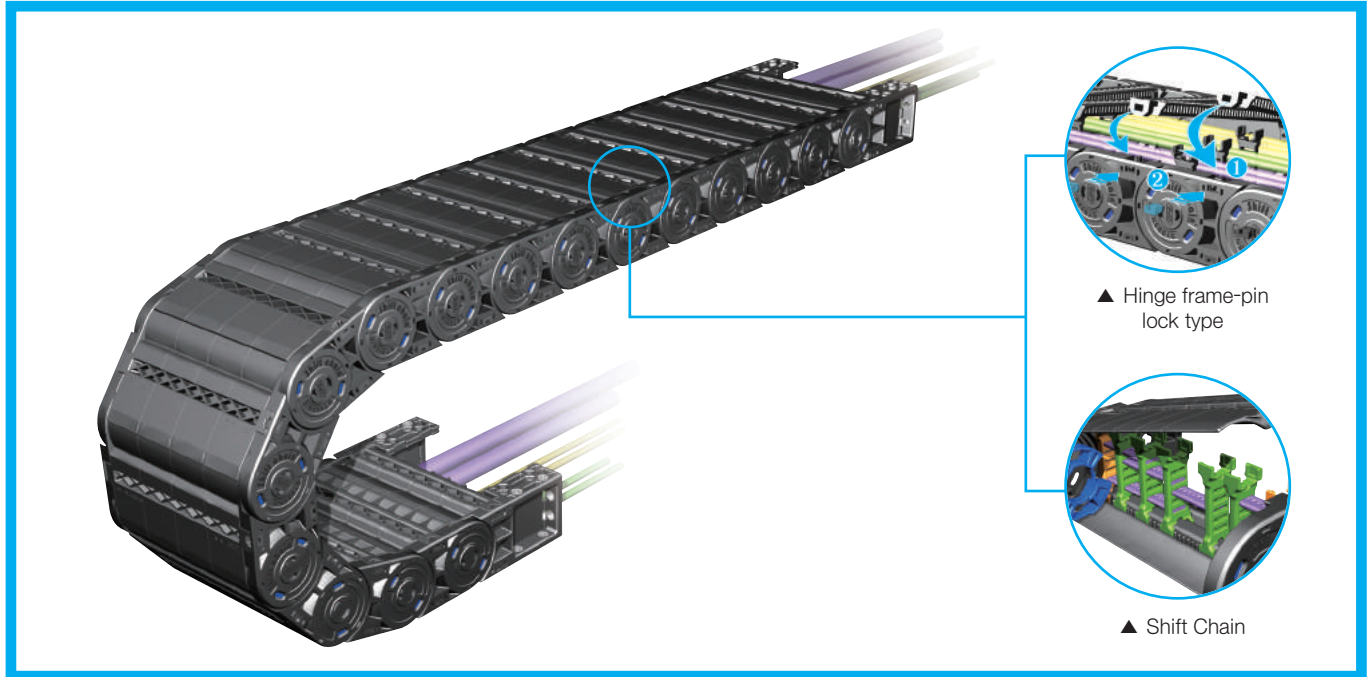

» Calculation of the chain length

$$[L = \frac{L_s}{2} + L_p]$$

» Other installation length

Vertical curve above = max 6.0m
 Vertical curve below = max 100m
 Side Mounted, Unsupported = max 3.0m

» Load diagrams self-supporting length

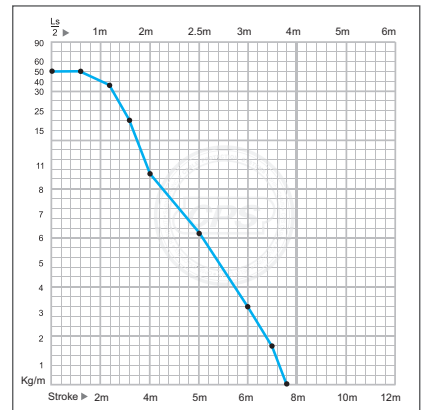

» Layout of the chain

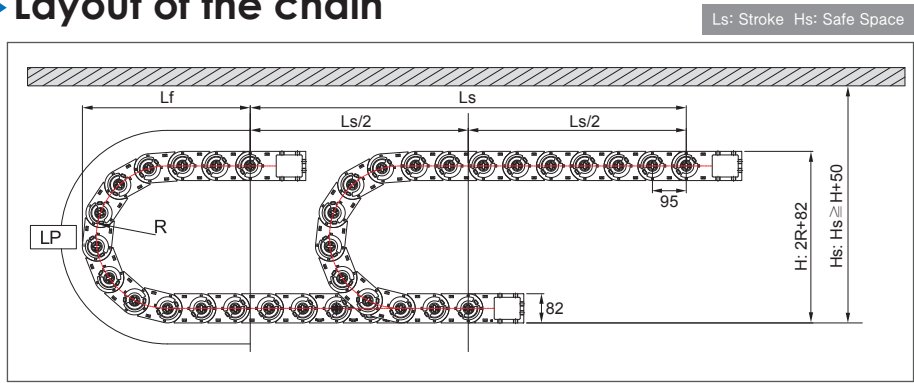

Bending Radius (R)	Lp Loop Length	Lf Loof Projection	H Moving Height
150	855	374	382
200	1,010	428	482
230	1,110	459	542
280	1,260	505	642
400	1,640	629	882

(Dimensions in mm)

» Chain cross section

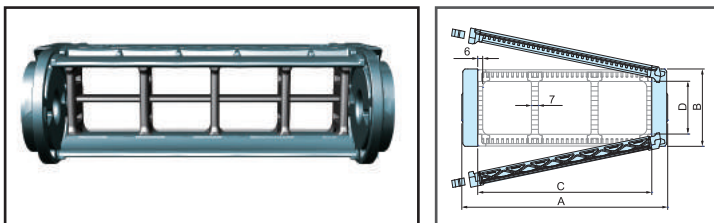

Chain Type	A Width (Outer)	B Height (Outer)	C Frame	D Height (Inner)	Weight kg/m
ST 095E	138	82	100	55	3.55
	163		125		3.79
	188		150		4.04
	213		175		4.29
	238		200		4.53

(Dimensions in mm)

» Dividers(DV)

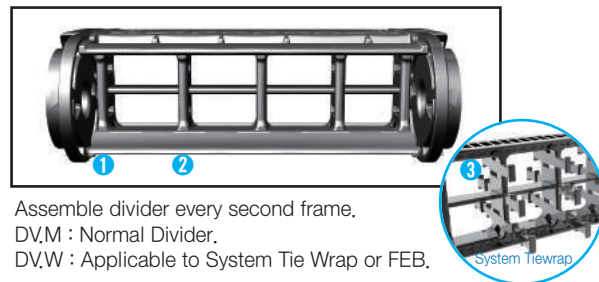

Assemble divider every second frame.
 D.V.M : Normal Divider.
 D.V.W : Applicable to System Tie Wrap or FEB.

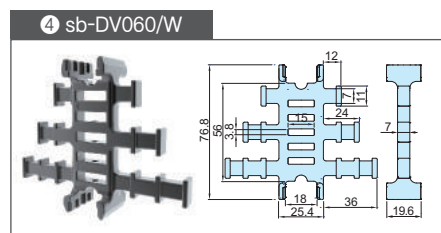
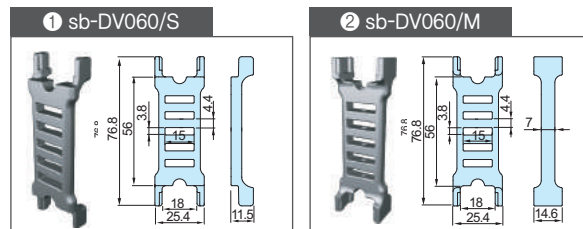

(Dimensions in mm)

» Free end bracket

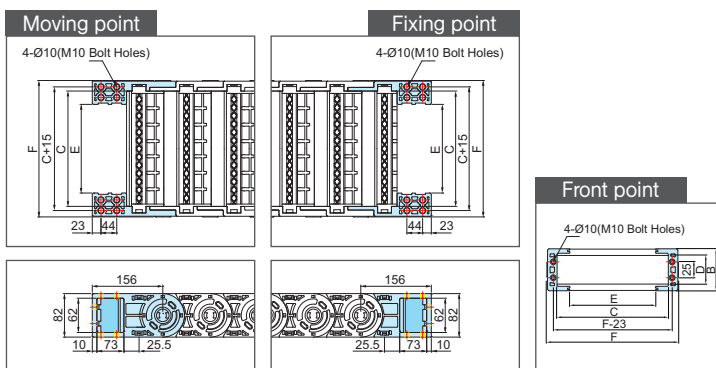

Chain Type	F Width(Outer)	B Height(Outer)	C Frame	D Height(Inner)	E M,EB Bolt hole width	Hole Type
ST 095E	138	82	100	55	49	M10 Bolt Holes
	163		125		74	
	188		150		99	
	213		175		124	
	238		200		149	

(Dimensions in mm)

» Separators(SP)

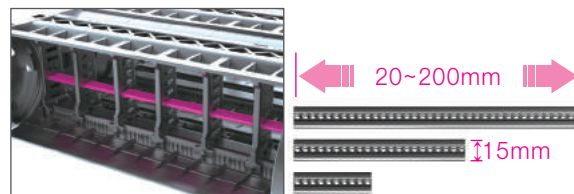

Chain Type	Ordering NO.
ST 095E	sb-SP/400,400

» System tie wrap (STW)

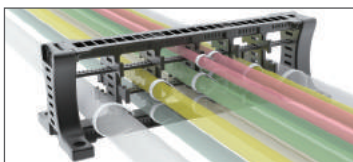

It is a unit to classify each cable for preventing entanglement of cables. It can either be installed to free end bracket or installed separately according its application environment.

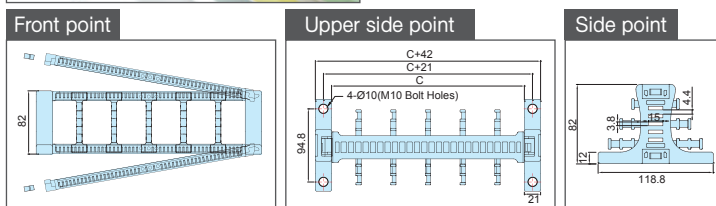

Chain Type	Ordering No.	C Frame	Hole Type
ST 095E	S-TW,EB060,100	100	M10 Bolt Holes
	S-TW,EB060,125	125	
	S-TW,EB060,150	150	
	S-TW,EB060,175	175	
	S-TW,EB060,200	200	

(Dimensions in mm)

» Tie wrap (TW)

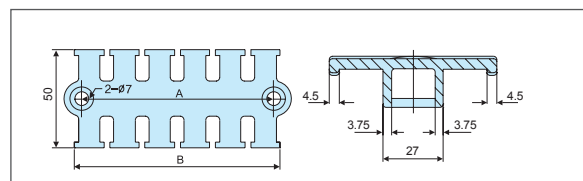
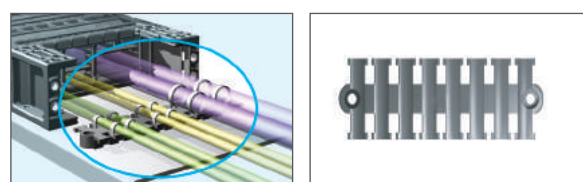

Chain Type	Ordering No.	A	B
ST 095E	S-TW50	58	65
	S-TW75	75	82
	S-TW100	98	105
	S-TW125	122	129
	S-TW150	141	148

(Dimensions in mm)

ST 120E

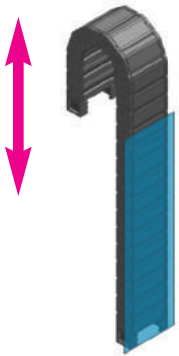
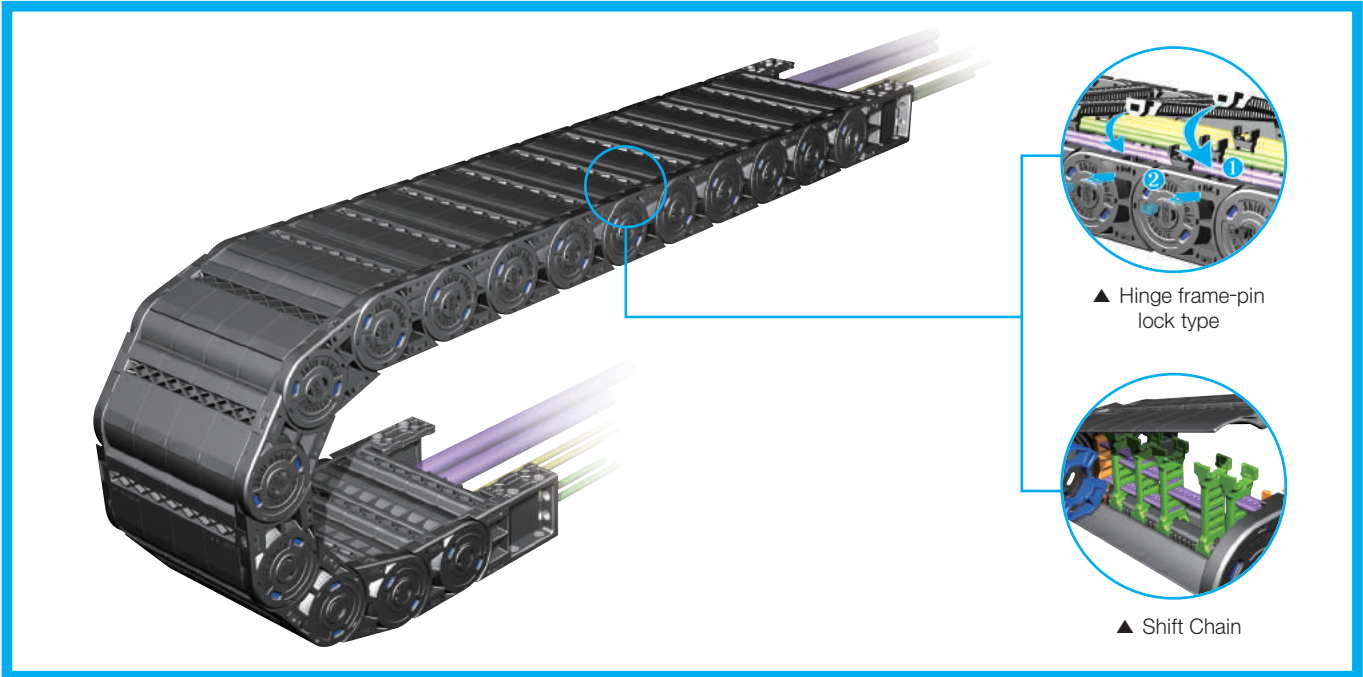

Vertical with curve above

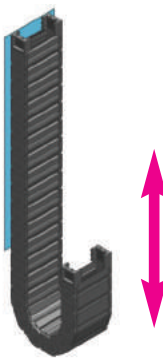

Vertical with curve below

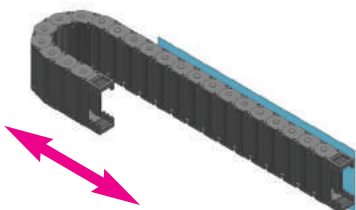

Horizontal application mounted on its side

» Calculation of the chain length

$$\left[L = \frac{L_s}{2} + L_p \right]$$

» Other installation length

Vertical curve above = max 6.0m
 Vertical curve below = max 120m
 Side Mounted, Unsupported = max 3.0m

» Load diagrams self-supporting length

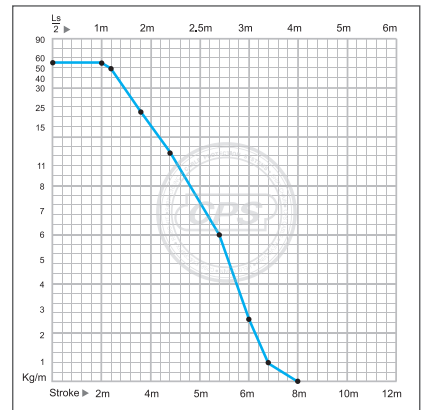

» Layout of the chain

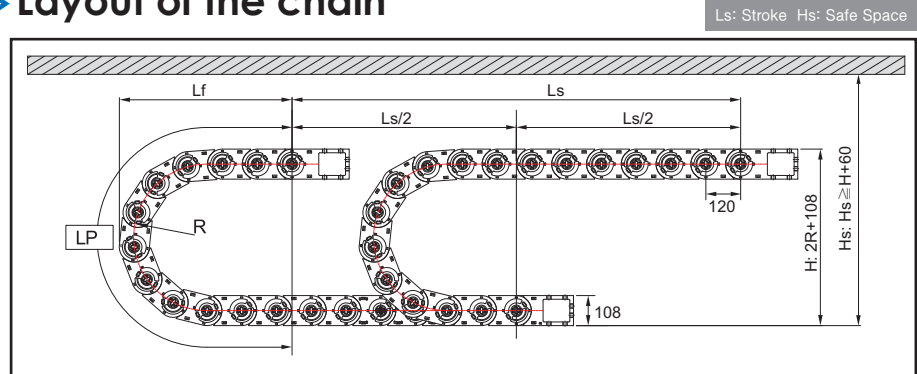

Bending Radius (R)	Lp Loop Length	Lf Loof Projection	H Moving Height
200	1,109	494	508
250	1,266	544	608
300	1,423	594	708
350	1,580	644	808
400	1,737	694	908
500	2,051	794	1,108

(Dimensions in mm)

» Chain cross section

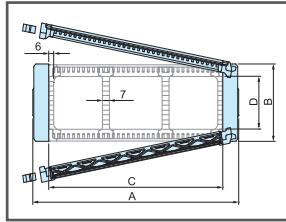
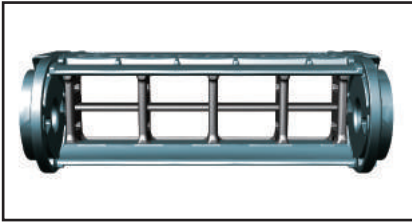

Chain Type	A Width (Outer)	B Height (Outer)	C Frame	D Height (Inner)	Weight kg/m
ST 120E	192	108	150	76	5.79
	242		200		6.43
	292		250		7.07
	342		300		7.71

(Dimensions in mm)

» Dividers(DV)

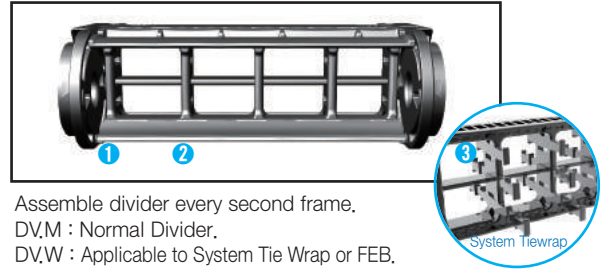

Assemble divider every second frame.
 D.V.M : Normal Divider.
 D.V.W : Applicable to System Tie Wrap or FEB.

1 sb-DV075/S

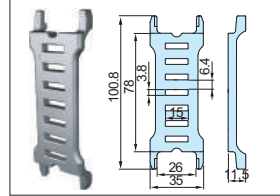

2 sb-DV075/M

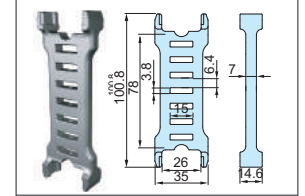

4 sb-DV075/W

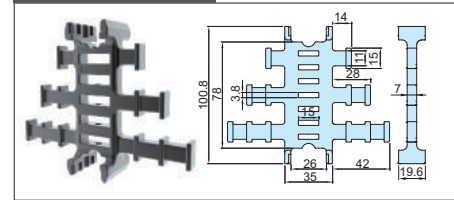

(Dimensions in mm)

» Free end bracket

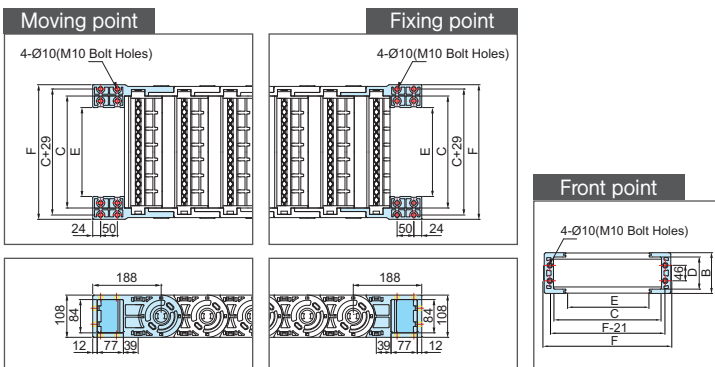

Chain Type	F Width(Outer)	B Height(Outer)	C Frame	D Height(Inner)	E M,EB Bolt hole width	Hole Type
ST 120E	200	108	150	76	90	M10 Bolt Holes
	250		140			
	300		190			
	350		240			

(Dimensions in mm)

» Separators(SP)

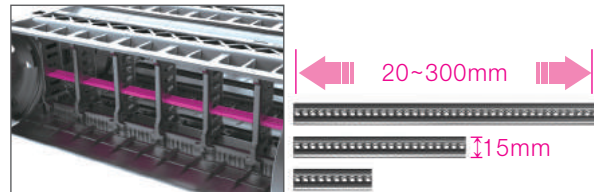

Chain Type	Ordering NO.
ST 120E	sb-SP/400,400

» System tie wrap (STW)

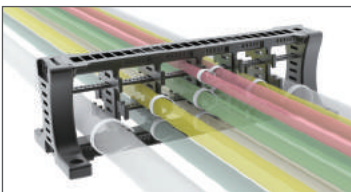

It is a unit to classify each cable for preventing entanglement of cables. It can either be installed to free end bracket or installed separately according its application environment.

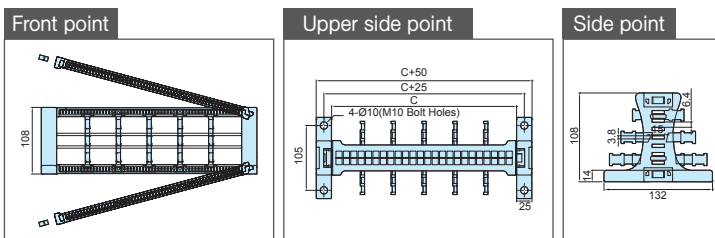

Chain Type	Ordering No.	C Frame	Hole Type
ST 120E	S-TWEB075,150	150	M10 Bolt Holes
	S-TWEB075,200	200	
	S-TWEB075,250	250	
	S-TWEB075,300	300	

» Tie wrap (TW)

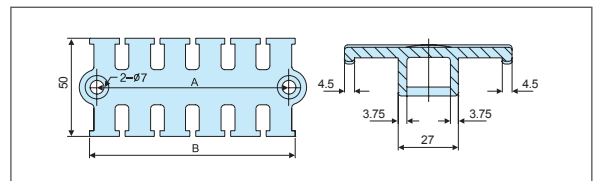
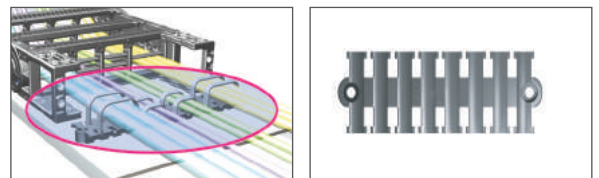

Chain Type	Ordering No.	A	B
ST 120E	S-TW50	58	65
	S-TW75	75	82
	S-TW100	98	105
	S-TW125	122	129
	S-TW150	141	148

(Dimensions in mm)

ST 150E

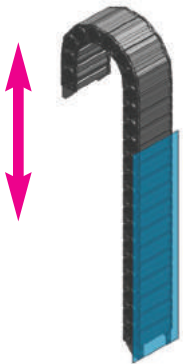
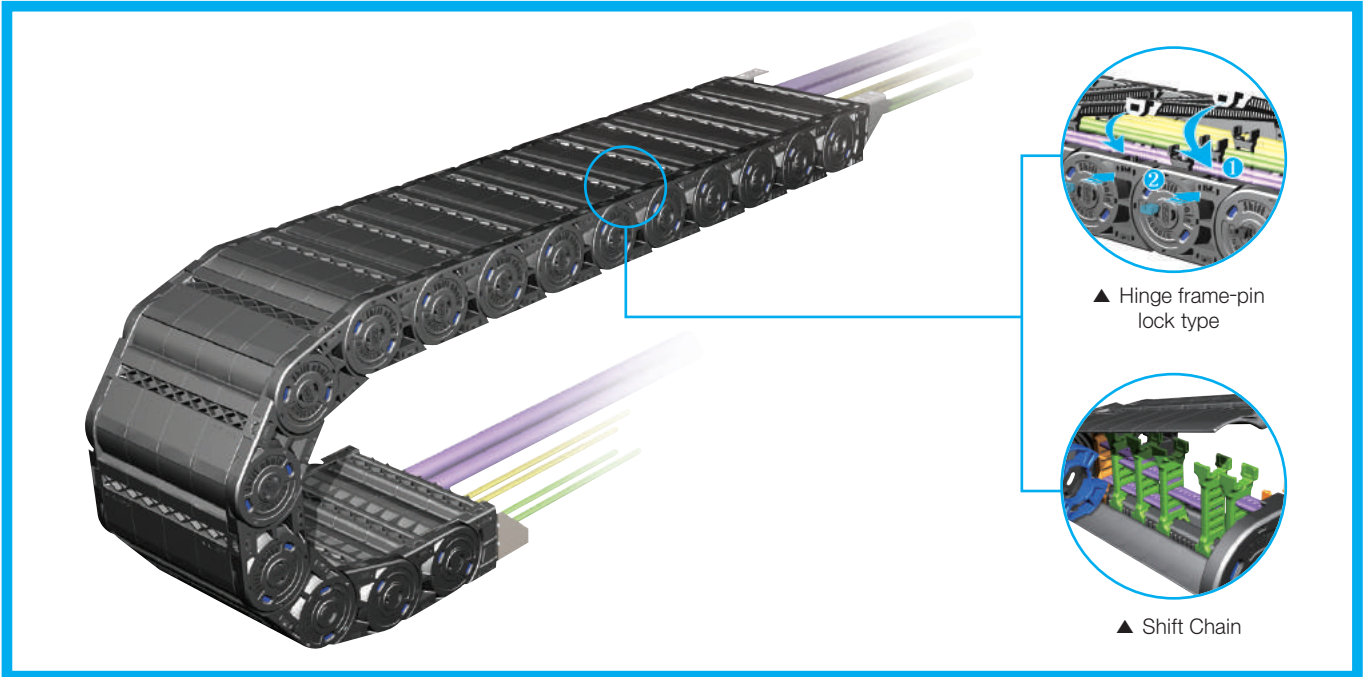

Vertical with curve above

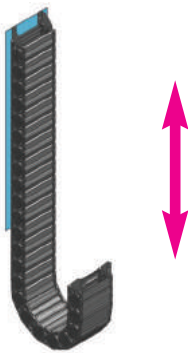

Vertical with curve below

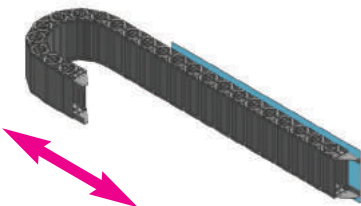

Horizontal application mounted on its side

» Calculation of the chain length

$$\left[L = \frac{L_s}{2} + L_p \right]$$

» Other installation length

Vertical curve above = max 7.0m
 Vertical curve below = max 150m
 Side Mounted, Unsupported = max 4.0m

» Load diagrams self-supporting length

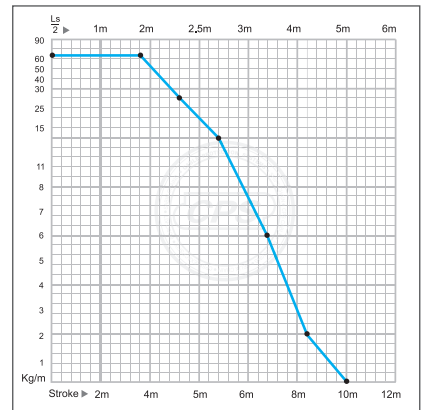

» Layout of the chain

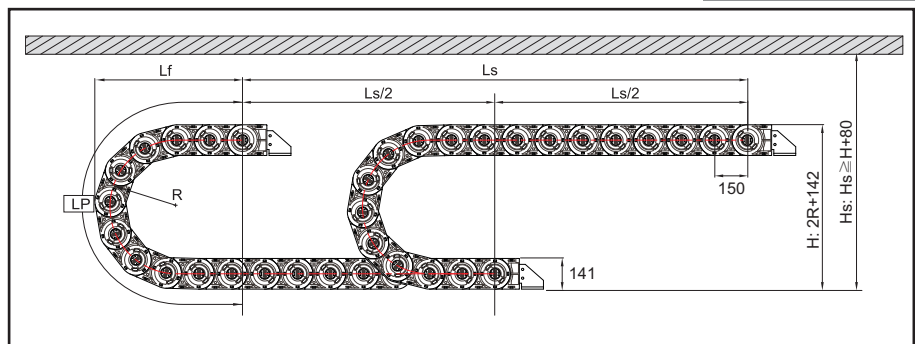

Bending Radius (R)	Lp Loop Length	Lf Loof Projection	H Moving Height
305	1,510	651	752
405	1,807	743	952
505	2,106	835	1,152
605	2,405	928	1,352

(Dimensions in mm)

» Chain cross section

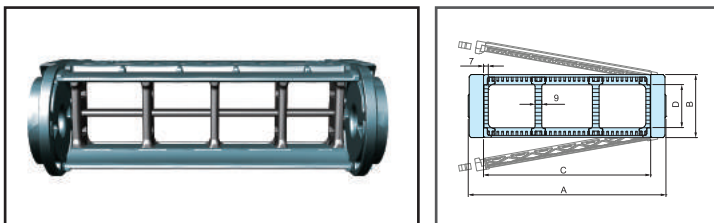

Chain Type	A Width (Outer)	B Height (Outer)	C Frame	D Height (Inner)	Weight kg/m
ST 150E	246	141	200	110	8.16
	296		250		8.76
	346		300		10.50
	396		350		12.33
	446		400		14.16

(Dimensions in mm)

» Dividers(DV)

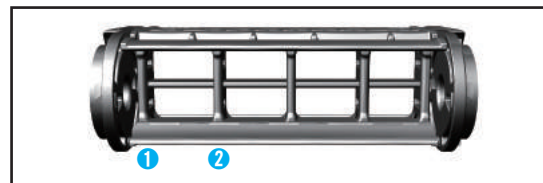

Assemble divider every second frame.
D.V.M : Normal Divider.

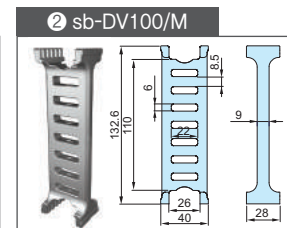
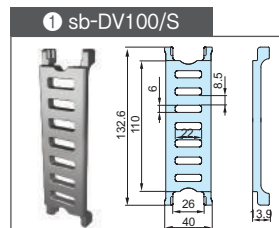

(Dimensions in mm)

» Free end bracket

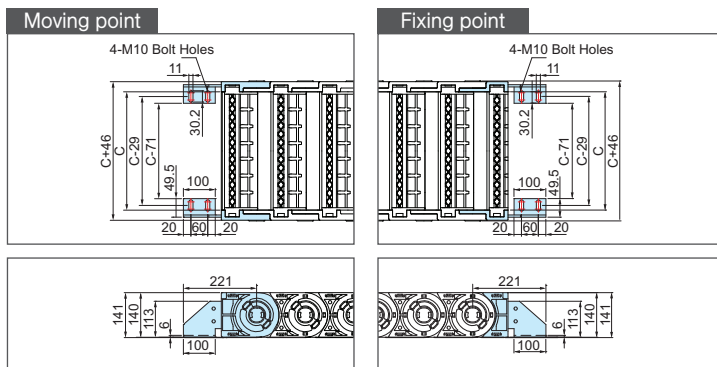

Chain Type	B Height(Outer)	C Frame	D Height(Inner)	Hole Type
ST 150E	141	200	110	M10 Bolt Holes
		250		
		300		
		350		
		400		

(Dimensions in mm)

» Separators(SP)

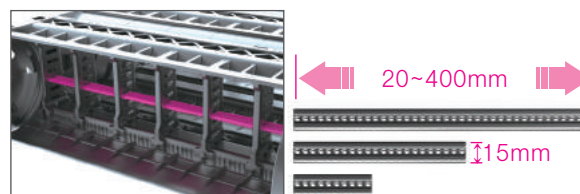

Chain Type	Ordering NO.
ST 150E	sb-SP/600,600

» Tie wrap (TW)

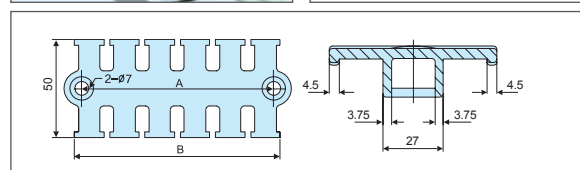
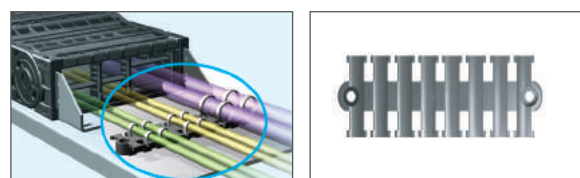

Chain Type	Ordering No.	A	B
ST 150E	S-TW50	58	65
	S-TW75	75	82
	S-TW100	98	105
	S-TW125	122	129
	S-TW150	141	148

(Dimensions in mm)

Shift Chain - Skid type



>> General information

Item	Value
Material	CPS-Amid(PA6+GF), RoHs
Speed	3m/s
Acceleration	10m/s ²
Temperature	-30°C ~+130°C
Certificate	CE, ATEX(Ex)

>> Calculation table

Item	Value
Length of Cable Chain	$L = \frac{1}{2} \times LS + LP$
Bending Radius	
The biggest Cable inserted	Multiply 8~10 and the biggest cable
The biggest Hydraulic Hose inserted	Multiply 15~20 and the biggest hose

>> Dimension table

Shift Chain S Type	Pitch	Bending Radius (R)	Weight kg/m	Speed m/s	Temperature °C	Size				Frame type	Section Composition	
						A	B	C	D			
ST 044S	44	70, 90, 120, 150	1.03	3	-30 ~ +130	74	35	38,5	100	26		
			1.08			89	50					
			1.10			94	55					
			1.17			114	75					
			1.26			139	100					
			1.40			164	125					
			1.52			189	150					
			1.81			214	175					
			1.98			239	200					

(Dimensions in mm)

>> Ordering

ST 044S. 100. R120 / F - 1500L : 10ST

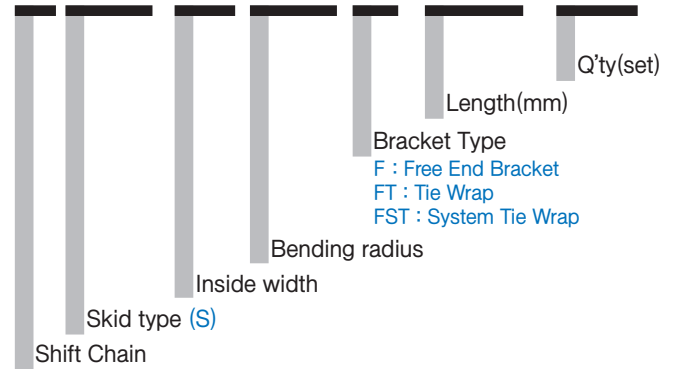

>> Bracket type

- ST044

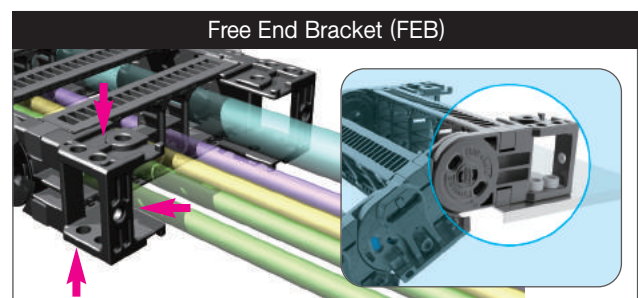

» Part list of Shift Chain Skid type

- Composition of Cable chain(Standard)
= Side band(RH) + Frame + Side band(LH) + Bending radius Unit + Free end bracket
- M divider(normal divider) should be applied every second frames to make a section composition.
- ※ Please refer to below part list and description to understand composition of cable chain.

Model	Classification	Part number	Description
ST044S	SIDE BAND	ST-SB044S(LH) ST-SB044S(RH)	Left side band of ST044S Right side band of ST044S
	BENDING RADIUS	ST-BRS044,R70,90,120,150	Bending radius unit for side band
	SKID	ST-SK044S(LH) ST-SK044S(RH)	Skid for long travel(Applied to side band)
	FRAME FRAME(UP)	sb-FR/M.35 sb-FR/M.50 sb-FR/M.55 sb-FR/M.75 sb-FR/M.100 sb-FR/M.125 sb-FR/M.150 sb-FR/M.175 sb-FR/M.200	Frame, 35mm Frame, 50mm Frame, 55mm Frame, 75mm Frame, 100mm Frame, 125mm Frame, 150mm Frame, 175mm Frame, 200mm
	FREE END BRACKET	End bracket of ST044S	End bracket of ST044S
	DIVIDER	sb-DV028/M sb-DV028/S	Normal divider To fix separators at the both side section
	SEPARATOR	S-SP/M.35 S-SP/M.50 S-SP/M.75 S-SP/M.100 S-SP/M.125 S-SP/M.150 S-SP/M.175 S-SP/M.200	Separator, 35mm Separator, 50mm Separator, 75mm Separator, 100mm Separator, 125mm Separator, 150mm Separator, 175mm Separator, 200mm
	TIE WRAP	S-TW036/025CR,35 S-TW036/025CR,55 S-TW036/025CR,75 S-TW036/025CR,100 S-TW036/025CR,125	Tie wrap for end bracket to fix cables, 35mm Tie wrap for end bracket to fix cables, 55mm Tie wrap for end bracket to fix cables, 75mm Tie wrap for end bracket to fix cables, 100mm Tie wrap for end bracket to fix cables, 125mm
	SYSTEM TIE WRAP	sb-DV028/W S-TWEB028	Divider for fixing cables at end bracket System tie wrap to arrange for cables right after moving bracket or fixing bracket

Shift Chain - Skid type

» Part of Shift Chain Skid type

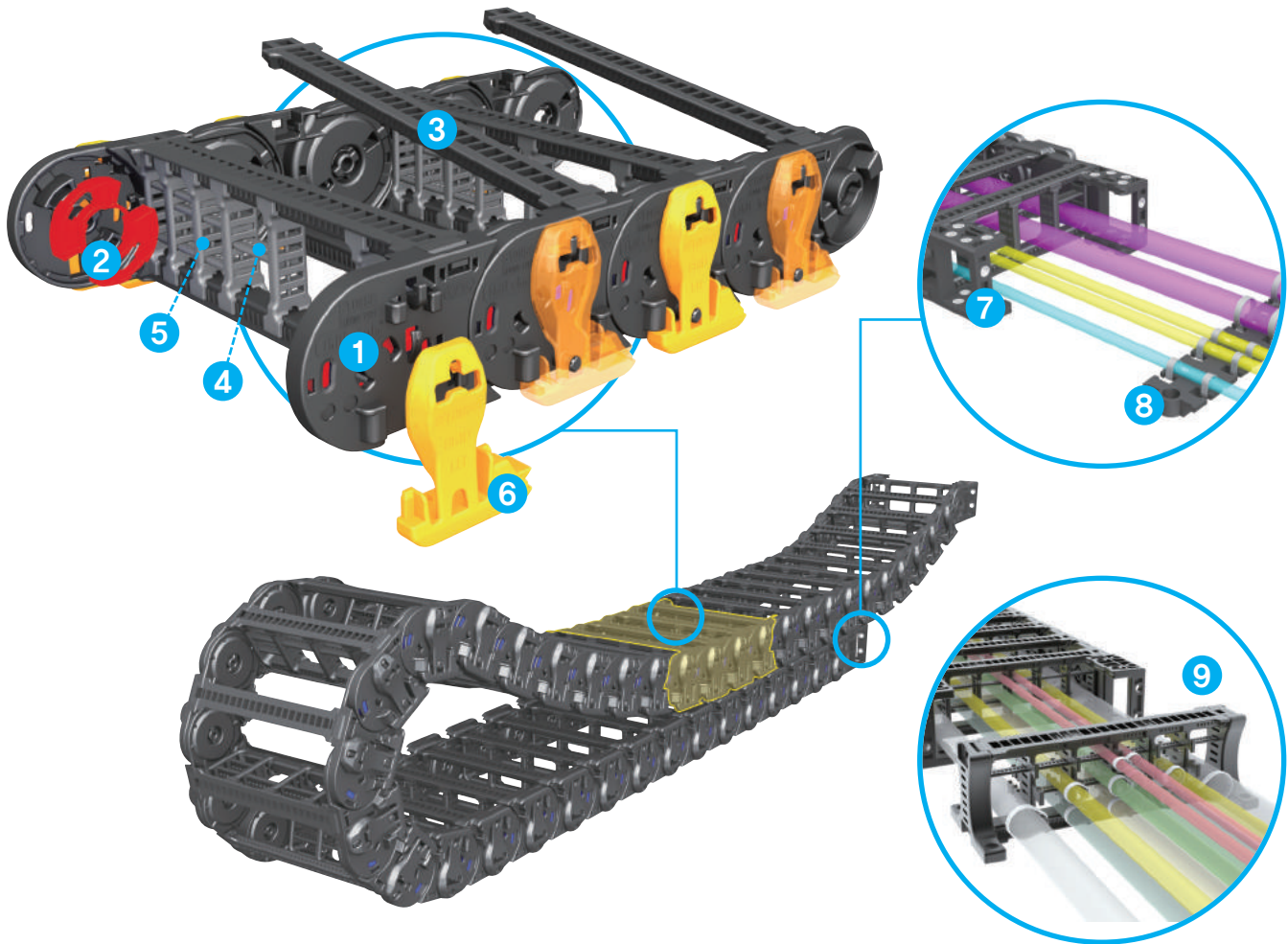

1 Side Band (SB)

A unit that connects each side band and between them BR is inserted to strengthen clamping force.

2 Bending Radius Unit (BR)

A unit that inserted between each side band. There are 6 supporting points to create durability.

5 Frame (Hinged Type) (FR)

Hinged-type frame, open one side, supports connection of both side of side band and have tongue and groove system plate to secure the position of the divider on the frame.

4 Separator (SP)

A unit that divides inserted cables vertically to prevent twisting and breaking problem.

5 Divider (DV-S, M, R, T)

A unit that divides inserted cables horizontally.

6 Skid

A unit that minimizes friction between upper and lower cable chain.

7 Free End Bracket (FEB)

A unit that connects at last side band (left&right). It can be fixed stronger using steel washers.

8 Tie Wrap (TW)

A unit that ties cables to maintain straightness of them. It can be assembled to bracket directly or installed separately from bracket.

9 System Tie Wrap (STW)

System-Tie Wrap has to be assembled on fixing and moving point of bracket and can be assembled without any tie wrap plate. This tie wrap is used to stay the cables on several floors prevent the cables from being twisted and it can also be assemble without any tools or bolt. This tie wrap has two types, one is to assemble inside bracket the other one is outside.

» Assembly procedure of Shift Chain Skid type

Assembly procedure of Shift chain S-type is as follows. The assembling process of shift Chain S-type is like below and you must use rubber hammer with careful combination of Divider and Separator. (Disassembly process for repair and replacement are in reverse order)



1
Insert BR Unit into each Side Band.
(Side Band is divided into right and left side according to the direction.)

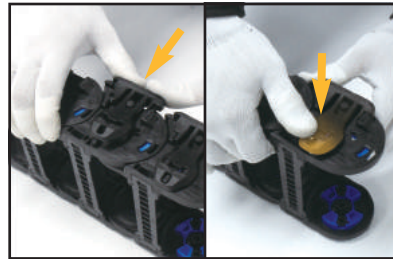

8
When inserting a Skid, push tightly to the home of Side Band until you hear "click"(Skid is divided each direction like right and left.)



2
Continue to insert BR Unit into Side Band as you want to make it. Assemble Side Band which is inserted BR Unit as above.



9
Assemble the Skid on the entire connected Side Band as same way.



3
Continue to connect each Side Band as long as you want to make it. Connect the Side Band as many as you need.

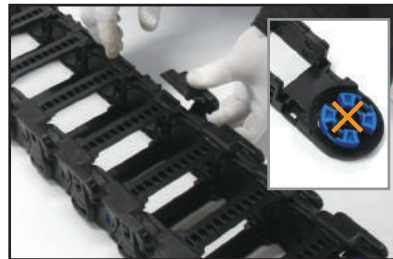

10
Assemble the Skid on the entire connected opposite side as well. Do not insert a BR Unit to M, FEB, (M, FEB will be making a turn to up and down)



4
Connect right and left link with specified frame.
(Put Hinge Type frame in the hole of Side Band)

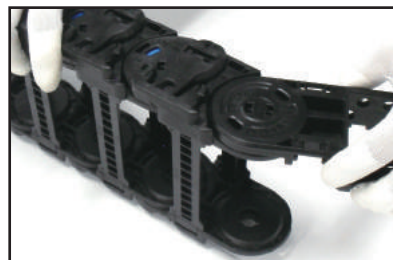

11
Assemble M, FEB to be corrective each direction such as right and left.



5
Insert frame pin onto connected each Frame and side of Side Band to be made tightly. (To divide inner room, insert divider which is connected with separator.



12
Assemble F, FEB to be suitable each direction such as right and left.
(Do not insert a BR Unit for the Side Band which is connected with F, FEB)



6
Assemble opposite frame as same procedure.



13
Assemble a specified frame in M, FEB and F, FEB. (Hinge is inserted into RH direction of FEB)
Insert Frame pin into connected frame and side of FEB.



7
Insert Skid to the protruding side of Side Band.



14
Insert steel washers into FEB according to fixing direction.

ST 044S

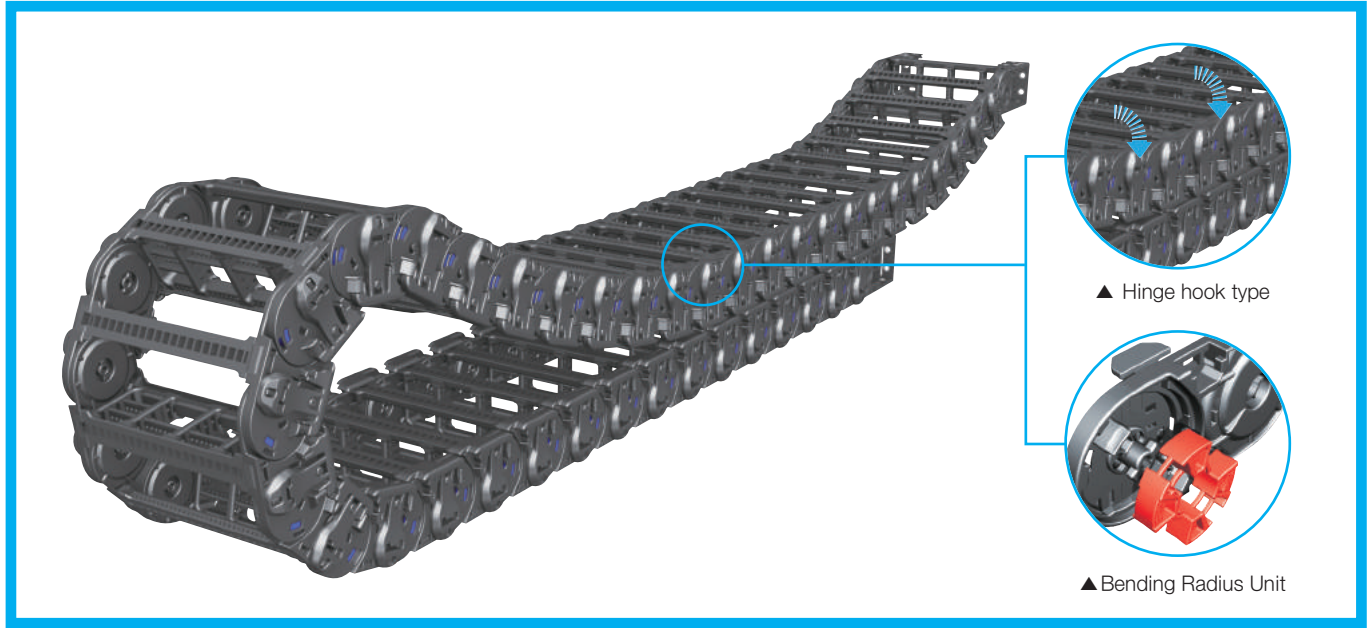

Layout of the chain

Ls: Stroke

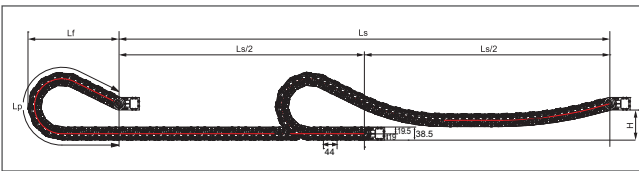

Bending Radius (R)	Lp Loop Length	Lf Loof Projection	H Moving Height
70	544	249	110
90	662	289	
120	926	393	
150	1,190	497	

(Dimensions in mm)

Chain cross section

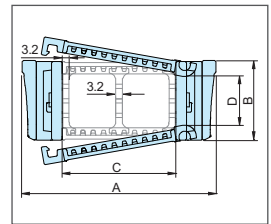
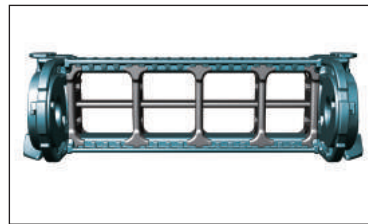

Chain Type	A Width(Outer)	B Height(Outer)	C Frame	D Height(Inner)	Weight kg/m
ST 044S	74	38,5	35	26	1,03
	89		50		1,08
	94		55		1,10
	114		75		1,17
	139		100		1,26
	164		125		1,40
	189		150		1,52
	214		175		1,81
239	200	1,98			

(Dimensions in mm)

Dividers(DV)

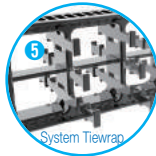
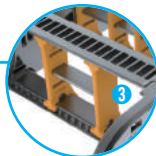
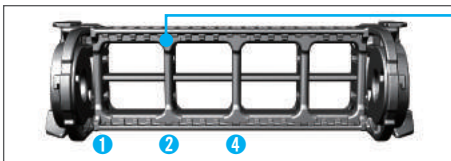

Assemble divider every second frame.
 DV.T : Applied to Frame 125~200.
 DV.M : Normal Divider.
 DV.W : Applicable to System Tie Wrap or FEB.

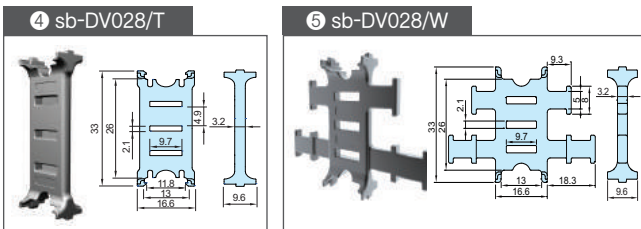
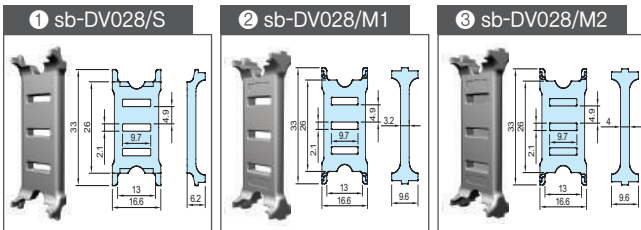

(Dimensions in mm)

Separators(SP)

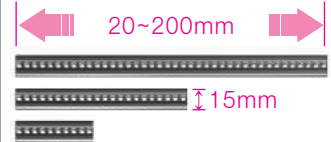
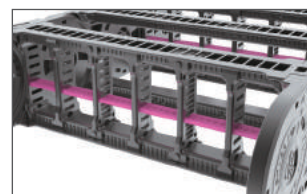

Chain Type	Ordering NO.	Frame
ST 044S	S-SP/M,35	35
	S-SP/M,50	50
	S-SP/M,55	55
	S-SP/M,75	75
	S-SP/M,100	100
	S-SP/M,125	125
	S-SP/M,150	150
	S-SP/M,175	175
S-SP/M,200	200	

(Dimensions in mm)

Free end bracket

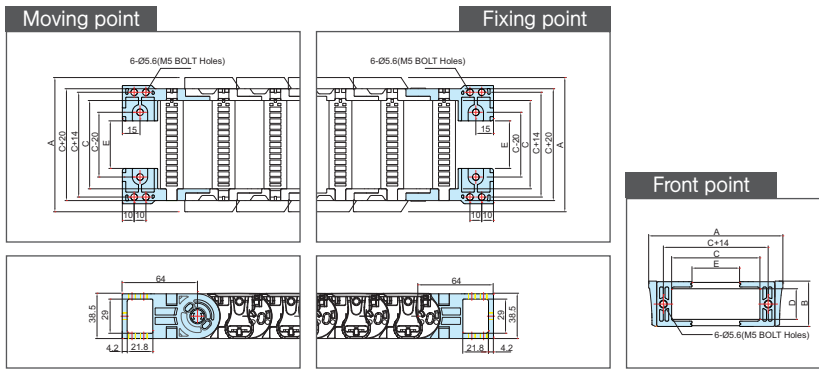

Chain Type	A Width(Outer)	B Height(Outer)	C Frame	D Height(Inner)	E M,EB Bolt hole width	Hole Type
ST 044S	74	38,5	35	26	0,4	M5 Bolt Holes
	89		50		15,4	
	94		55		20,4	
	114		75		40,4	
	139		100		65,4	
	164		125		90,4	
	189		150		115,4	
	214		175		140,4	
	239		200		165,4	

(Dimensions in mm)

System tie wrap (STW)

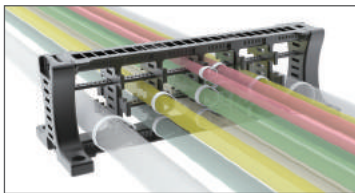

It is a unit to classify each cable for preventing entanglement of cables. It can either be installed to free end bracket or installed separately according its application environment.

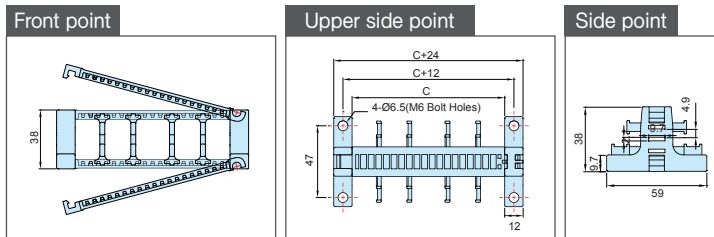

Chain Type	Ordering No.	C Frame	Hole Type
ST 044S	S-TW,EB028,35	35	M6 Bolt Holes
	S-TW,EB028,50	50	
	S-TW,EB028,55	55	
	S-TW,EB028,75	75	
	S-TW,EB028,100	100	
	S-TW,EB028,125	125	
	S-TW,EB028,150	150	
	S-TW,EB028,175	175	
	S-TW,EB028,200	200	

(Dimensions in mm)

Tie wrap (TW)

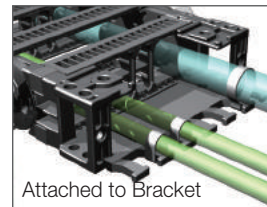

Attached to Bracket

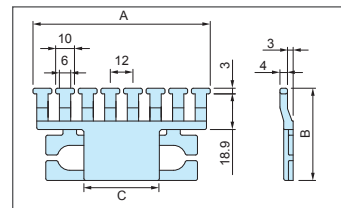

Chain Type	Ordering No.	A	B	C
ST 044S	S-TW036/025CR,35	46	35,4	-
	S-TW036/025CR,50	69	48,9	15
	S-TW036/025CR,55	70	48,9	20
	S-TW036/025CR,75	94	48,9	40
	S-TW036/025CR,100	118	48,9	65
	S-TW036/025CR,125	142	48,9	90

(Dimensions in mm)

Guide channel

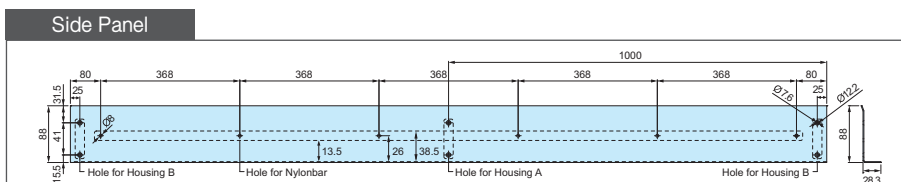
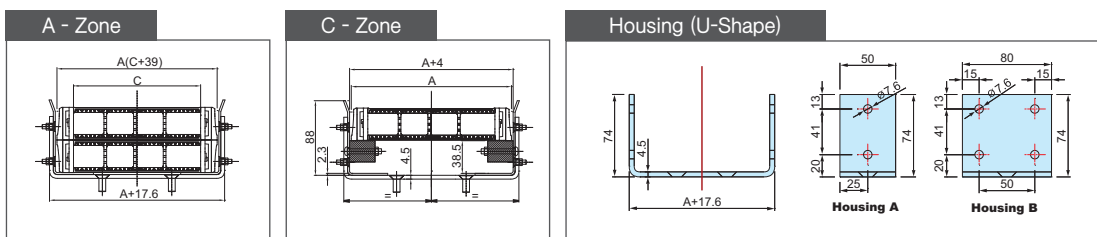

(Dimensions in mm)

Shift Chain - Enclosed roller skid type

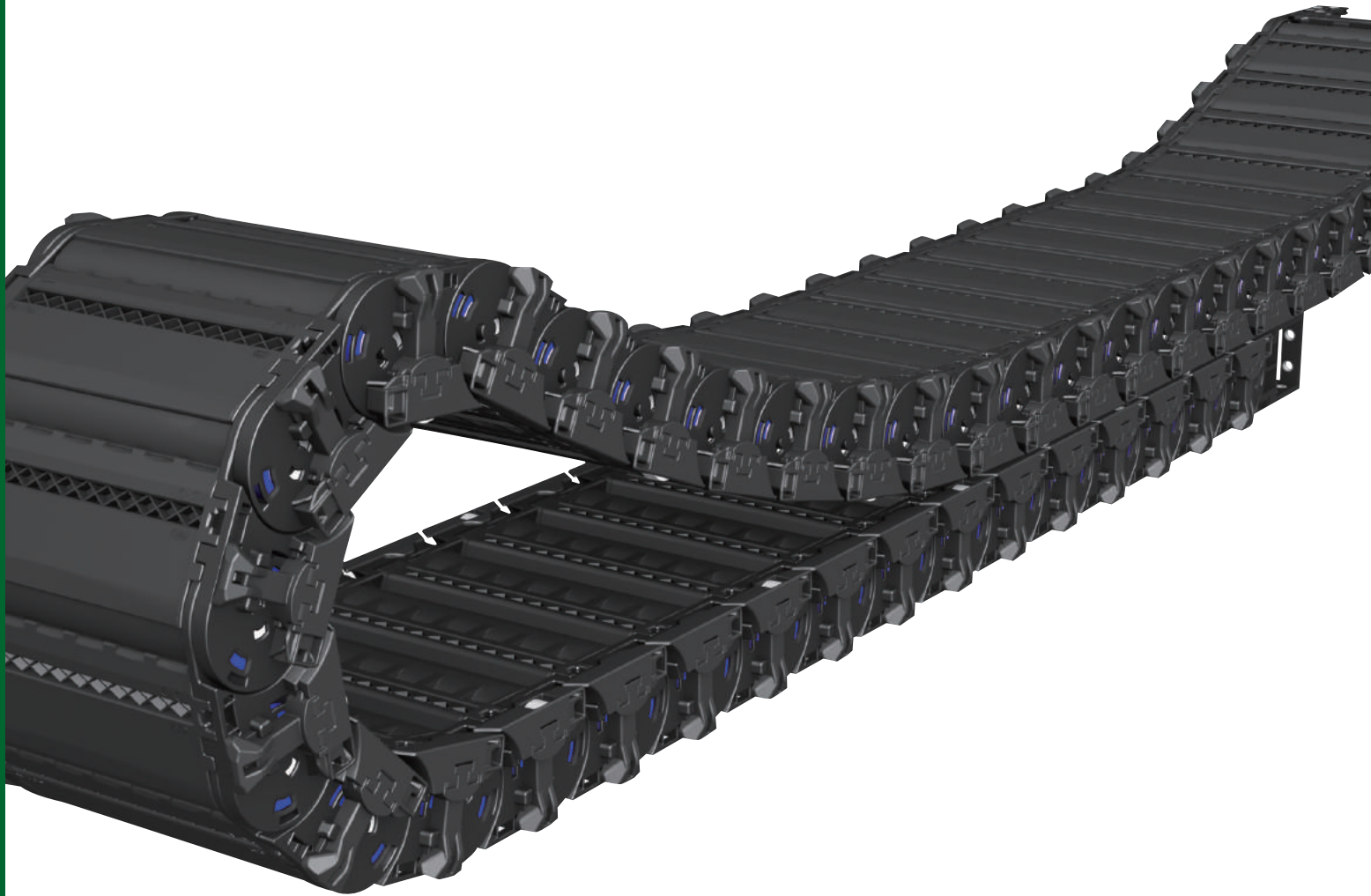

>> General information

Item	Value
Material	CPS-Amid(PA6+GF), RoHs
Speed	3m/s
Acceleration	10m/s ²
Temperature	-30°C ~+130°C
Certificate	CE, ATEX(Ex)

>> Calculation table

Item	Value
Length of Cable Chain	$L = \frac{1}{2} \times LS + LP$
Bending Radius	
The biggest Cable inserted	Multiply 8~10 and the biggest cable
The biggest Hydraulic Hose inserted	Multiply 15~20 and the biggest hose

» Dimension table

Shift Chain ERS Type	Pitch	Bending Radius (R)	Weight kg/m	Speed m/s	Temperature °C	Clearance				Frame style	Divider possible with frame
						A	B	C	D		
ST 044ERS	44	70, 90, 120, 150	1.07	3	-30 ~ +130	73	40.5	35	24.5		
			1.16			93		55			
			1.23			113		75			
			1.33			138		100			
ST 072ERS	72	120, 145, 200, 250, 300	2.53	3	-30 ~ +130	104	69	50	44		
			2.65			129		75			
			2.77			154		100			
			2.89			179		125			
			3.01			204		150			
ST 095ERS	95	150, 200, 230, 280, 400	4.20	3	-30 ~ +130	168	85	100	55		
			4.45			193		125			
			4.70			218		150			
			4.95			243		175			
			5.19			268		200			
ST 120ERS	120	200, 250, 300, 350, 400, 500	5.17	3	-30 ~ +130	218	112	150	76		
			5.48			268		200			
			5.78			318		250			
			6.09			368		300			
ST 150ERS	150	305, 405, 505, 605	10.23	3	-30 ~ +130	287	145	200	110		
			10.84			337		250			
			11.45			387		300			
			12.06			437		350			
			12.67			487		400			

(Dimensions in mm)

» Ordering

ST 044ERS, 100, R120 / F - 1500L : 10ST

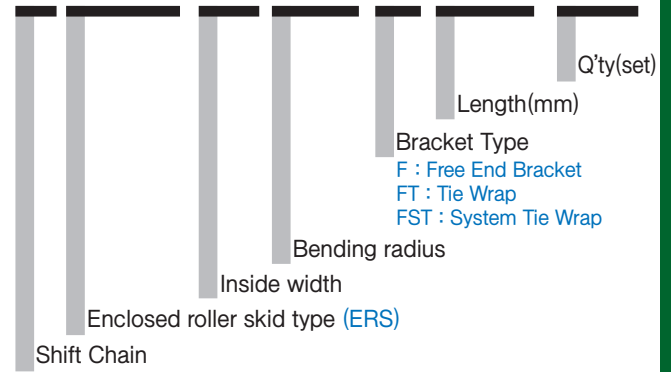

» Bracket type

- ST044, ST072, ST095, ST120

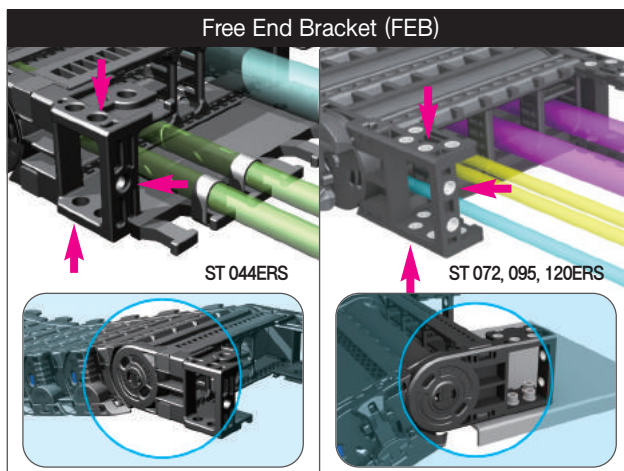

- ▶ BR should not be inserted in the joint of side band and Free End Bracket.
- ▶ Normal Frame, not FRU/FRD, is inserted into Free End Bracket.

Shift Chain - Enclosed roller skid type

» Part of Shift Chain Enclosed Roller skid type

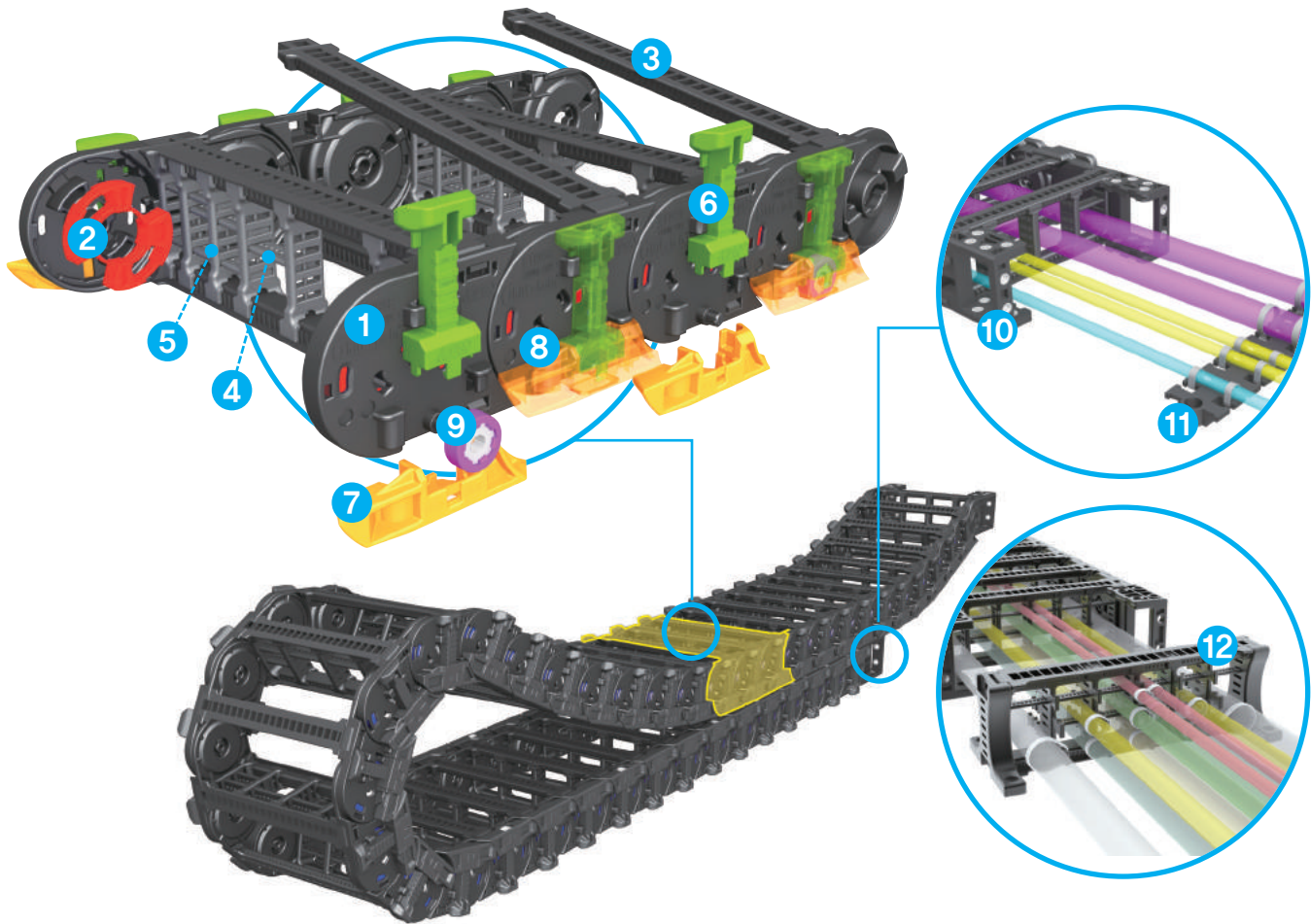

1 Side Band (SB)

A unit that connects each side band and between them BR is inserted to strengthen clamping force.

2 Bending Radius Unit (BR)

A unit that inserted between each side band. There are 6 supporting points to create durability.

3 FRU, FRD [FRU(D) Enclosed type applicable]

A unit that connects left and right side band and there are 2 types of frame : FRU, FRD.

4 Separator (SP)

A unit that divides inserted cables vertically to prevent twisting and breaking problem.

5 Divider (DV-S, M, R, T)

A unit that divides inserted cables horizontally.

6 Support

A unit that supports skid & roller skid which makes skid & roller skid move up and down.

7 8 Skid, Roller Skid

Skid : A unit that minimizes friction between upper and lower cable chain.
Roller Skid : A unit that minimizes friction between upper and lower cable chain, while roller is combined type..

9 Roller

A unit that minimizes friction between upper and lower cable chain. It contains bearing in the core.

10 Free End Bracket (FEB)

A unit that connects at last side band (left&right). It can be fixed stronger using steel washers.

11 Tie Wrap (TW)

A unit that ties cables to maintain straightness of them. It can be assembled to bracket directly or installed separately from bracket.

12 System Tie Wrap (STW)

System-Tie Wrap has to be assembled on fixing and moving point of bracket and can be assembled without any tie wrap plate. This tie wrap is used to stay the cables on several floors prevent the cables from being twisted and it can also be assemble without any tools or bolt. This tie wrap has two types, one is to assemble inside bracket the other one is outside.

» Assembly procedure of Shift Chain Enclosed Roller skid type

Assembly procedure of Shift chain ERS-type is as follows. The assembling process of shift Chain ERS-type is like below and users must use rubber hammer with careful combination of Divider and Separator. (Disassembly process for repair and replacement is in reverse order)



1 Insert BR Unit into each Side Band. (Side Band is divided into right and left side according to the direction.)

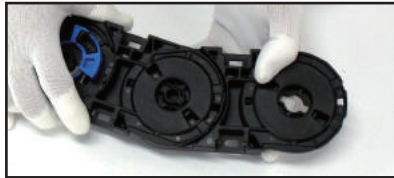

2 Continue to insert BR Unit into Side Band as you want to make it. Assembly Side Band which is inserted BR Unit as above.



3 Continue to connect each Side Band as long as you want to make it.



4 Connect the Side Band as many as you need.

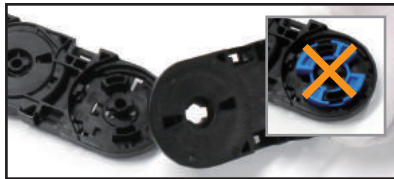

5 Assemble the F.FEB according to the direction of right and left side. (Do not insert the BR Unit to Side Band connected to F.FEB. Side of F.FEB is not enclosed.)

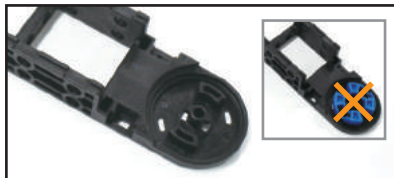

6 Do not insert a BR to M.FEB. (M.FEB will be making a turn to up and down.)



7 Assemble the M.FEB according to the direction of right and left side. (Side of M.FEB is not enclosed.)

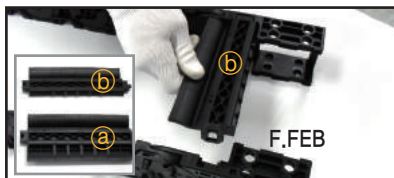

8 Insert one ⑥ Shaped-FRD into F.FEB. (③: Normal FRD ⑥: Built-up only for F.FEB) Find one ⑥ shaped-FRD and insert it with the hinge facing RH direction, as above.

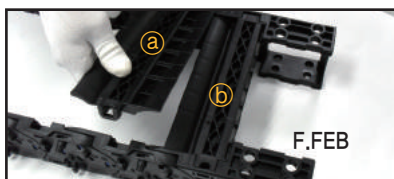

9 Continue to insert the FRD (③: Normal FRD ⑥: Built-up only for F.FEB) with the hinge facing RH direction. (Assemble the from F.FEB to M.FEB in order.)



10 Insert the frame as many as you need and insert them one by one with the hinge facing RH direction, as above. (M.FEB is not turned to up and down when FRD assembling)

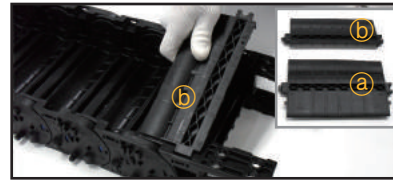

11 Insert the ⑥ shaped-FRD inserted to F.FEB and insert it with the hinge facing RH direction, as above. (③: Normal FRD ⑥: Built-up only for F.FEB) Insert the divider with separator to divide the inside of chain.

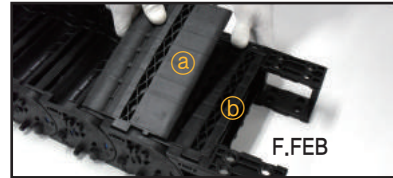

12 Continue to insert the FRU (③: Normal FRU) with the hinge facing RH direction. (Assemble the from F.FEB to M.FEB in order.)

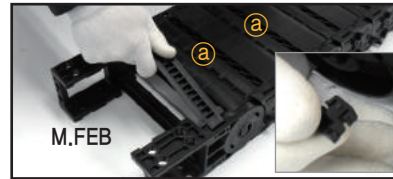

13 Insert ③ Normal FRU as many as you need and insert them one by one with the hinge facing RH direction, as above. Insert Frame-pin into the hole which is seen where the end of FRU and Side Band meet. (M.FEB is not turning to up and down when FRU assembling.)



14 Insert Roller into mounted Side Band.



15 Continue to insert Roller into Side Band. Basically, you insert one roller per 4 Link.



16 Insert Roller Skid into Side Band where roller inserted in. Skid is divided into Roller Skid (Skid with mount for roller) and normal Skid. (Skid without mount)

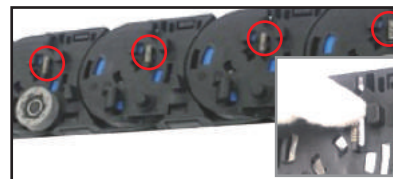

17 Insert support into groove of side band until you hear the "click". (Same support for both LH and RH.)



18 Insert a normal Skid into Side Band which is not inserted a roller.



19 Insert Skid and Support into all Side Band links. (Check that Skid is working up-and-down properly when you push the assembled Skids by hands.)

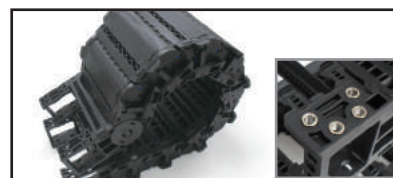

20 Insert steel washers into M.FEB and F.FEB.

Shift Chain - Enclosed roller skid type

Part of Shift Chain Enclosed Roller skid type

- Composition of Cable chain(Standard)
= Side band(RH) + Frame + Side band(LH) + Bending radius Unit + Free end bracket
- M divider(normal divider) should be applied every second frames to make a section composition.
- ※ Please refer to below part list and description to understand composition of cable chain.

Model	Classification	Part number	Description
ST044ERS	SIDE BAND	ST-SB044S(LH) ST-SB044S(RH)	Left side band of ST044S Right side band of ST044S
	BENDING RADIUS	ST-BRS044.R70, 90, 120, 150	Bending radius unit for side band
	SKID	ST-SK044RS(LH-N) ST-SK044RS(LH-R) ST-SK044RS(RH-N) ST-SK044RS(RH-R)	Skid for long travel(Applied to side band)
	SPRING	ST-SPR044	Supporter to fix skid unit
	SUPPORT	ST-SUP044	Spring with roller
	ROLLER	ST-RL044	Roller for long travel(Applied to side band)
	FRAME(DOWN) FRAME(UP)	ST-FRD044,35 ST-FRU044,35 ST-FRD044,55 ST-FRU044,55 ST-FRD044,75 ST-FRU044,75 ST-FRD044,100 ST-FRU044,100	Inside frame, 35mm Outside frame, 35mm Inside frame, 55mm Outside frame, 55mm Inside frame, 75mm Outside frame, 75mm Inside frame, 100mm Outside frame, 100mm
	FRAME(DOWN-FIXING END) FRAME(UP-FIXING END) FRAME(DOWN-MOVING END) FRAME(UP-MOVING END)	ST-FRD044,35,55,75,100 ST-FRU044,35,55,75,100 ST-FRD044,35,55,75,100 ST-FRU044,35,55,75,100	Inside half-frame for fixing end bracket Outside half-frame for fixing end bracket Inside half-frame for moving end bracket Outside half-frame for moving end bracket
	FREE END BRACKET	ST-FEB044E	End bracket of ST044E
	DIVIDER	sb-DV028/M sb-DV028/S	Normal divider To fix separstors at the both side section
	SEPARATOR	S-SP/M,35 S-SP/M,50 S-SP/M,75 S-SP/M,100	Separator, 35mm Separator, 50mm Separator, 75mm Separator, 100mm
	TIE WRAP	S-TW036/025CR,35 S-TW036/025CR,55 S-TW036/025CR,75 S-TW036/025CR,100 S-TW036/025CR,125	Tie wrap for end bracket to fix cables, 35mm Tie wrap for end bracket to fix cables, 55mm Tie wrap for end bracket to fix cables, 75mm Tie wrap for end bracket to fix cables, 100mm Tie wrap for end bracket to fix cables, 125mm
	SYSTEM TIE WRAP	sb-DV028/W S-TW,EB028	Divider for fixing cables at end bracket System tie wrap to arrange for cables right after moving bracket or fixing bracket

Model	Classification	Part number	Description
ST072ERS	SIDE BAND	ST-SB072S(LH) ST-SB072S(RH)	Left side band of ST072S Right side band of ST072S
	BENDING RADIUS	ST-BRS072. R120,145,200,250,300	Bending radius unit for side band
	SKID	ST-SK072RS(LH-N) ST-SK072RS(LH-R) ST-SK072RS(RH-N) ST-SK072RS(RH-R)	Skid for long travel(Applied to side band)
	SPRING	ST-SPR072	Supporter to fix skid unit
	SUPPORT	ST-SUP072	Spring with roller
	ROLLER	ST-RL072	Roller for long travel(Applied to side band)
	FRAME PIN	S-FP/S1	Frame pin
	FRAME(DOWN) FRAME(UP)	ST-FRD072,50 ST-FRU072,50 ST-FRD072,75 ST-FRU072,75 ST-FRD072,100 ST-FRU072,100 ST-FRD072,125 ST-FRU072,125 ST-FRD072,150 ST-FRU072,150	Inside frame, 50mm Outside frame, 50mm Inside frame, 75mm Outside frame, 75mm Inside frame, 100mm Outside frame, 100mm Inside frame, 125mm Outside frame, 125mm Inside frame, 150mm Outside frame, 150mm
	FRAME(DOWN-FIXING END) FRAME(UP-FIXING END) FRAME(DOWN-MOVING END) FRAME(UP-MOVING END)	ST-FRD072,50,75,100,125,150 ST-FRU072,50,75,100,125,150 ST-FRD072,50,75,100,125,150 ST-FRU072,50,75,100,125,150	Inside half-frame for fixing end bracket Outside half-frame for fixing end bracket Inside half-frame for moving end bracket Outside half-frame for moving end bracket
	FREE END BRACKET	ST-FEB072 sb-FEB/WH045	End bracket of ST072E Steel washer for end bracket
	DIVIDER	sb-DV045/M sb-DV045/S	Normal divider To fix separstors at the both side section
	SEPARATOR	sb-SP/400,400 SP-PIN045	Separator, 400mm Separator pin to fix
	TIE WRAP	S-TW50 S-TW75 S-TW100 S-TW125 S-TW150	Tie wrap for end bracket to fix cables, 50mm Tie wrap for end bracket to fix cables, 75mm Tie wrap for end bracket to fix cables, 100mm Tie wrap for end bracket to fix cables, 125mm Tie wrap for end bracket to fix cables, 150mm
	SYSTEM TIE WRAP	sb-DV045/W S-TW,EB045	Divider for fixing cables at end bracket System tie wrap to arrange for cables right after moving bracket or fixing bracket

Model	Classification	Part number	Description
ST095ERS	SIDE BAND	ST-SB095S(LH) ST-SB095S(RH)	Left side band of ST095S Right side band of ST095S
	BENDING RADIUS	ST-BR095,R150,200,230,280,400	Bending radius unit for side band
	SKID	ST-SK095RS(LH-N) ST-SK095RS(LH-R) ST-SK095RS(RH-N) ST-SK095RS(RH-R)	Skid for long travel(Applied to side band)
	SPRING	ST-SPR095	Supporter to fix skid unit
	SUPPORT	ST-SUP095	Spring with roller
	ROLLER	ST-RL095	Roller for long travel(Applied to side band)
	FRAME PIN	S-FP/S1	Frame pin
	FRAME(DOWN) FRAME(UP)	ST-FRD095,100 ST-FRU095,100 ST-FRD095,125 ST-FRU095,125 ST-FRD095,150 ST-FRU095,150 ST-FRD095,175 ST-FRU095,175 ST-FRD095,200 ST-FRU095,200	Inside frame, 100mm Outside frame, 100mm Inside frame, 125mm Outside frame, 125mm Inside frame, 150mm Outside frame, 150mm Inside frame, 175mm Outside frame, 175mm Inside frame, 200mm Outside frame, 200mm
	FRAME(DOWN-FIXING END) FRAME(UP-FIXING END) FRAME(DOWN-MOVING END) FRAME(UP-MOVING END)	ST-FRD095,100,125,150,175,200 ST-FRU095,100,125,150,175,200 ST-FRD095,100,125,150,175,200 ST-FRU095,100,125,150,175,200	Inside half-frame for fixing end bracket Outside half-frame for fixing end bracket Inside half-frame for moving end bracket Outside half-frame for moving end bracket
	FREE END BRACKET	ST-FEB095E	End bracket of ST095E
	DIVIDER	sb-DV060/M sb-DV060/S	Normal divider To fix separstors at the both side section
	SEPARATOR	sb-SP/400,400 SP-PIN060	Separator, 400mm Separator pin to fix
	TIE WRAP	S-TW50 S-TW75 S-TW100 S-TW125 S-TW150	Tie wrap for end bracket to fix cables, 50mm Tie wrap for end bracket to fix cables, 75mm Tie wrap for end bracket to fix cables, 100mm Tie wrap for end bracket to fix cables, 125mm Tie wrap for end bracket to fix cables, 150mm
	SYSTEM TIE WRAP	sb-DV060/W S-TW,EB060	Divider for fixing cables at end bracket System tie wrap to arrange for cables right after moving bracket or fixing bracket

Model	Classification	Part number	Description
ST120ERS	SIDE BAND	ST-SB120S(LH) ST-SB120S(RH)	Left side band of ST120E Right side band of ST120E
	BENDING RADIUS	ST-BR120,R180,200,250,300,350,400,500	Bending radius unit for side band
	SKID	ST-SK120RS(LH-N) ST-SK120RS(LH-R) ST-SK120RS(RH-N) ST-SK120RS(RH-R)	Skid for long travel(Applied to side band)
	SPRING	ST-SPR120 ST-SUP120	Supporter to fix skid unit
	SUPPORT	ST-SUP120	Spring with roller
	ROLLER	ST-RL120	Roller for long travel(Applied to side band)
	FRAME PIN	S-FP/S2	Frame pin
	FRAME(DOWN) FRAME(UP)	ST-FRD120,150 ST-FRU120,150 ST-FRD120,200 ST-FRU120,200 ST-FRD120,250 ST-FRU120,250 ST-FRD120,300 ST-FRU120,300	Inside frame, 150mm Outside frame, 150mm Inside frame, 200mm Outside frame, 200mm Inside frame, 250mm Outside frame, 250mm Inside frame, 300mm Outside frame, 300mm
	FRAME(DOWN-FIXING END) FRAME(UP-FIXING END) FRAME(DOWN-MOVING END) FRAME(UP-MOVING END)	ST-FRD120,150,200,250,300 ST-FRU120,150,200,250,300 ST-FRD120,150,200,250,300 ST-FRU120,150,200,250,300	Inside half-frame for fixing end bracket Outside half-frame for fixing end bracket Inside half-frame for moving end bracket Outside half-frame for moving end bracket
	FREE END BRACKET	ST-FEB120E sb-FEB/WH075	End bracket of ST120E Steel washer for end bracket
	DIVIDER	sb-DV075/M sb-DV075/S	Normal divider To fix separstors at the both side section
	SEPARATOR	sb-SP/400,400 SP-PIN075	Separator, 400mm Separator pin to fix
	TIE WRAP	S-TW50 S-TW75 S-TW100 S-TW125 S-TW150	Tie wrap for end bracket to fix cables, 50mm Tie wrap for end bracket to fix cables, 75mm Tie wrap for end bracket to fix cables, 100mm Tie wrap for end bracket to fix cables, 125mm Tie wrap for end bracket to fix cables, 150mm
	SYSTEM TIE WRAP	sb-DV075/W S-TW,EB075	Divider for fixing cables at end bracket System tie wrap to arrange for cables right after moving bracket or fixing bracket

ST 044ERS

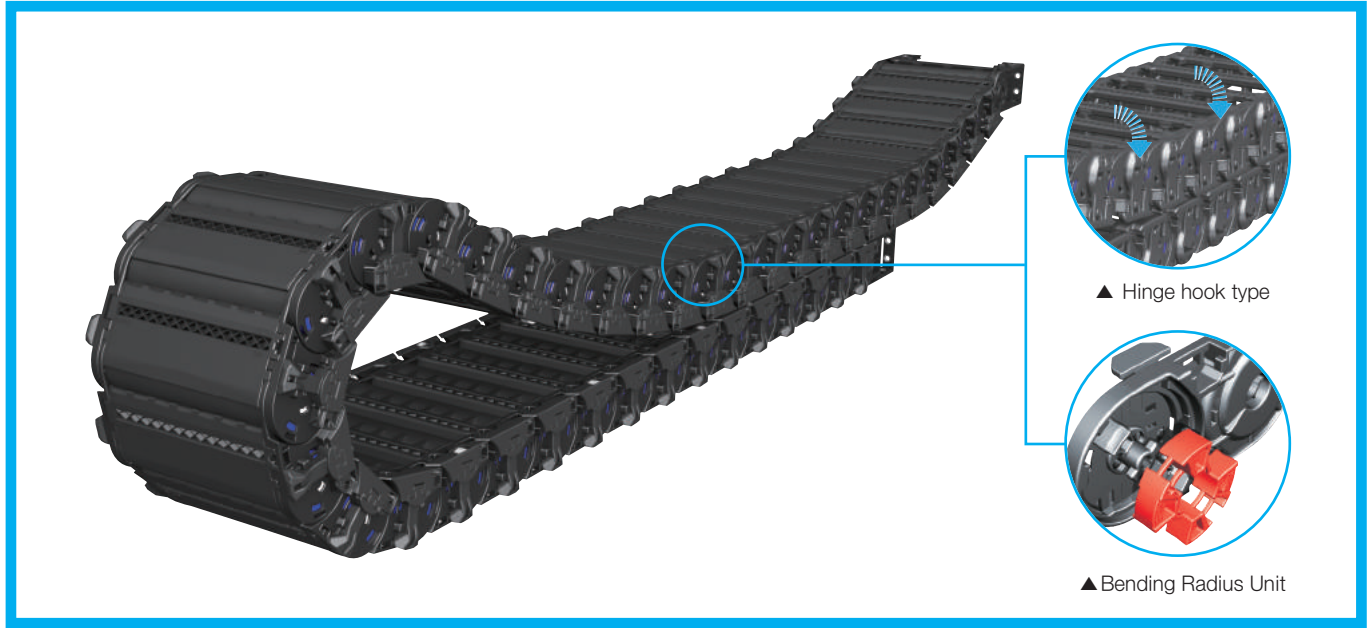

» Layout of the chain

Ls: Stroke

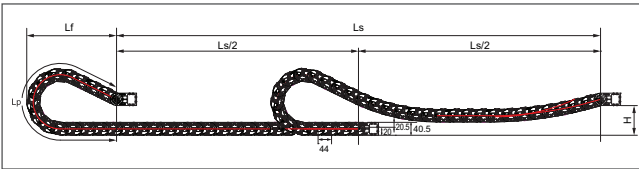

Bending Radius (R)	Lp Loop Length	Lf Loop Projection	H Moving Height
70	544	249	110
90	662	289	
120	926	393	
150	1,190	497	

(Dimensions in mm)

» Chain cross section

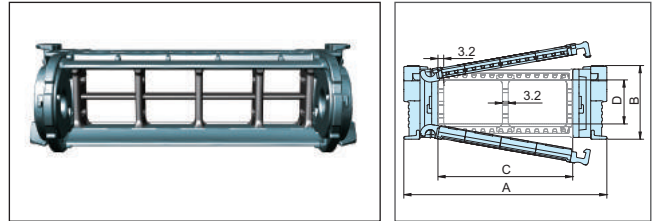

Chain Type	A Width(Outer)	B Height(Outer)	C Frame	D Height(Inner)	Weight kg/m
ST 044ERS	73	40.5	35	24.5	1.07
	93		55		1.16
	113		75		1.23
	138		100		1.33

(Dimensions in mm)

» Dividers(DV)

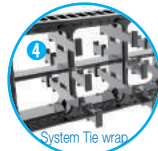
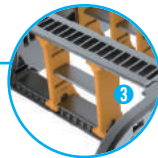
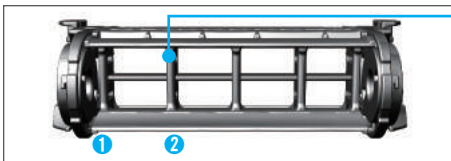

Assemble divider every second frame.
 DV.M : Normal Divider.
 DV.W : Applicable to System Tie Wrap or FEB.

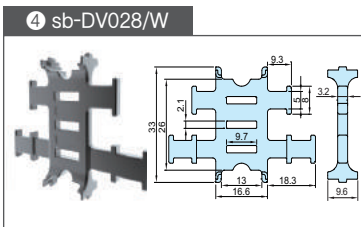
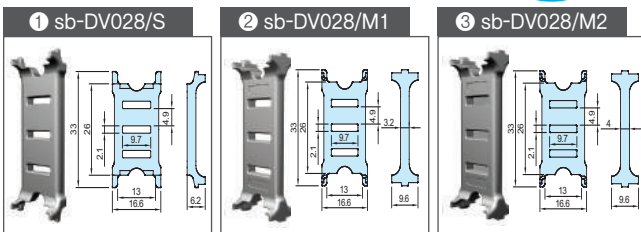

(Dimensions in mm)

» Separators(SP)

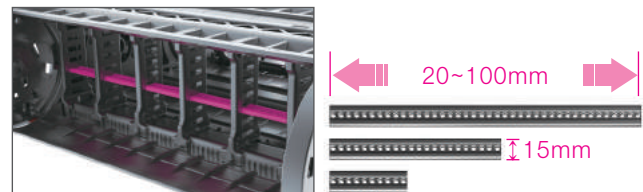

Chain Type	Ordering NO.	Frame
ST 044ERS	S-SP/M.35	35
	S-SP/M.55	55
	S-SP/M.75	75
	S-SP/M.100	100

(Dimensions in mm)

Free end bracket

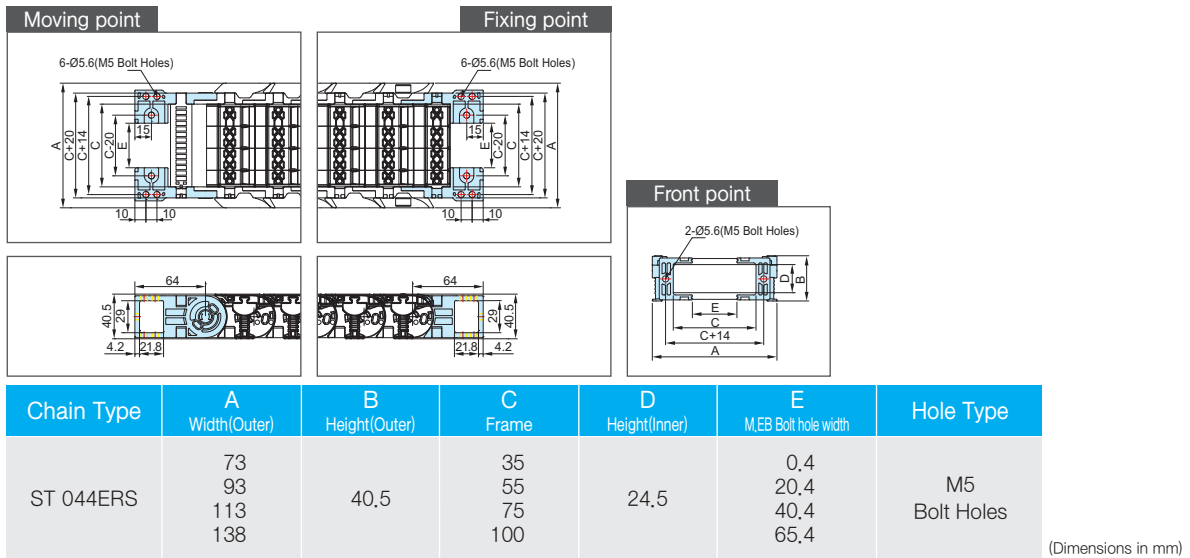

System tie wrap (STW)

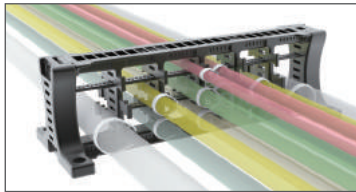

It is a unit to classify each cable for preventing entanglement of cables. It can either be installed to free end bracket or installed separately according to its application environment.

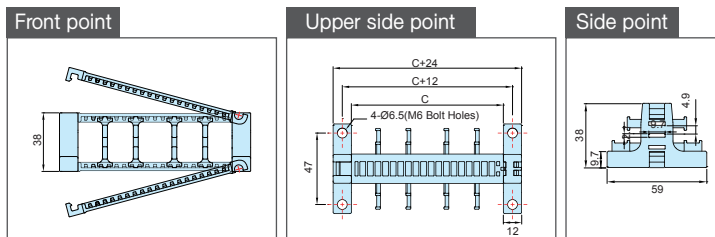

Chain Type	Ordering No.	C Frame	Hole Type
ST 044ERS	S-TWEB028,35	35	M6 Bolt Holes
	S-TWEB028,55	55	
	S-TWEB028,75	75	
	S-TWEB028,100	100	

(Dimensions in mm)

Tie wrap (TW)

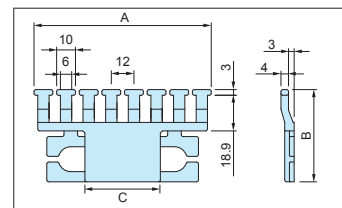
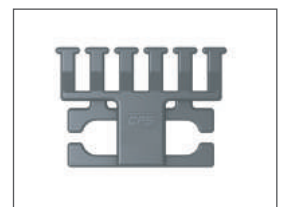
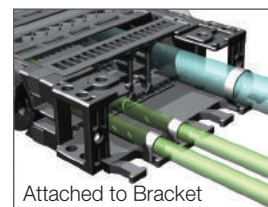

Chain Type	Ordering No.	A	B	
ST 044ERS	S-TW036/025CR,35	46	35.4	-
	S-TW036/025CR,55	70	48.9	20
	S-TW036/025CR,75	94	48.9	40
	S-TW036/025CR,100	118	48.9	65

(Dimensions in mm)

Guide channel

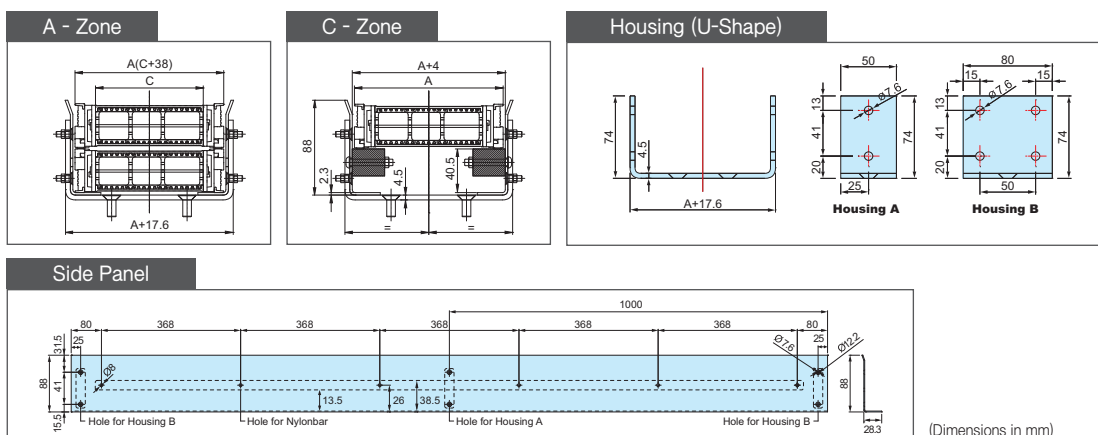

ST 072ERS

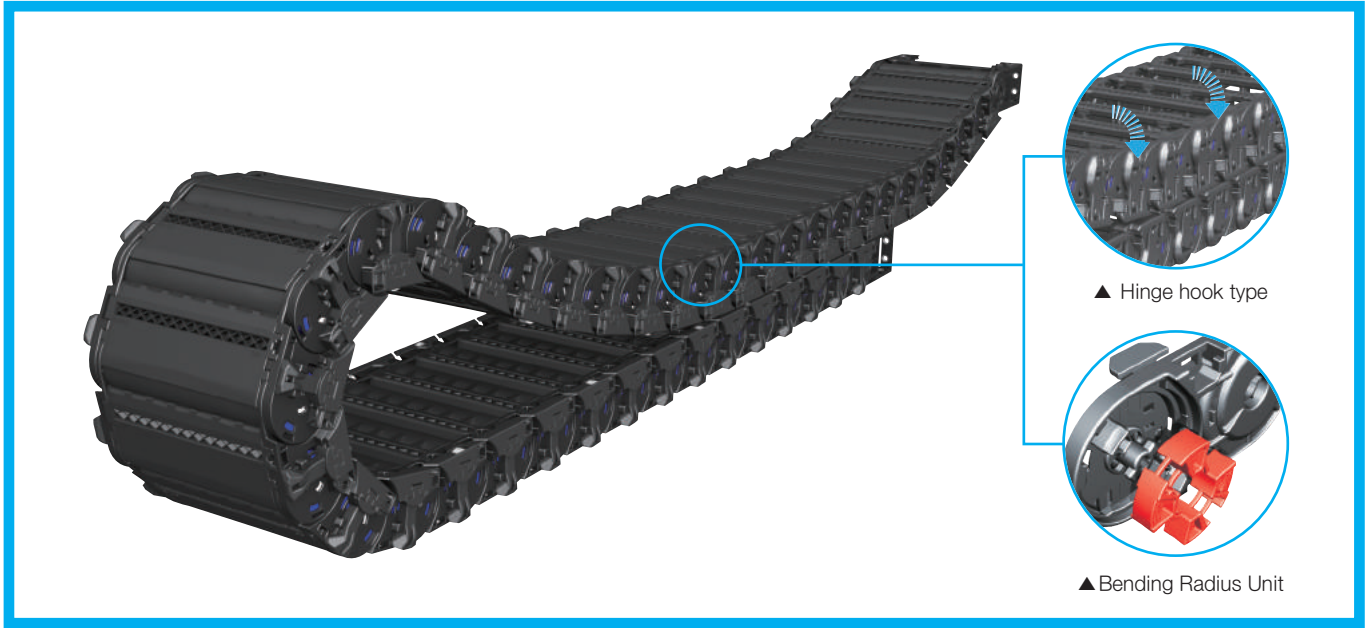

Layout of the chain

Ls: Stroke

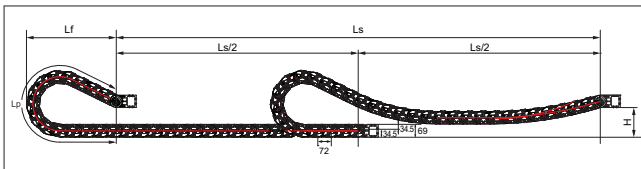

Bending Radius (R)	Lp Loop Length	Lf Loof Projection	H Moving Height
120	917	420	180
145	1,063	470	
200	1,400	580	
250	1,840	752	
300	2,280	924	

(Dimensions in mm)

Chain cross section

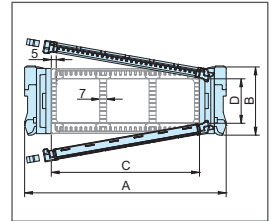
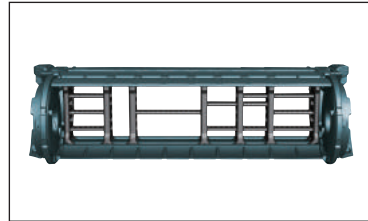

Chain Type	A Width(Outer)	B Height(Outer)	C Frame	D Height(Inner)	Weight kg/m
ST 072ERS	104	69	50	44	2.53
	129		75		2.65
	154		100		2.77
	179		125		2.89
	204		150		3.01

(Dimensions in mm)

Dividers(DV)

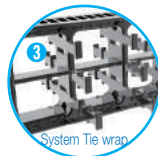
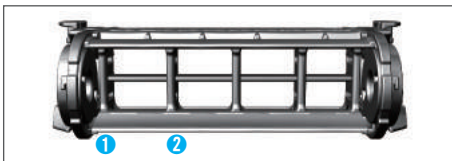

Assemble divider every second frame.
 DV.M : Normal Divider.
 DV.W : Applicable to System Tie Wrap or FEB.

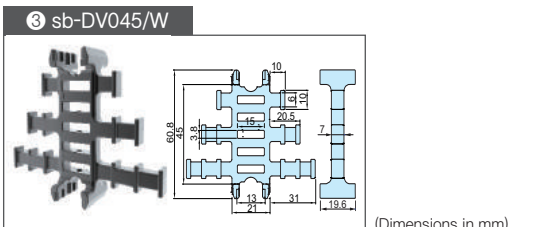
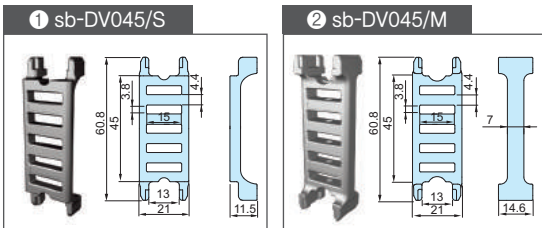

(Dimensions in mm)

Separators(SP)

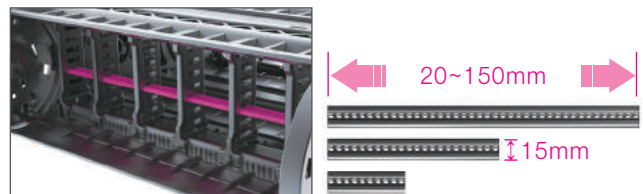

Chain Type	Ordering NO.
ST 072ERS	sb-SP/400,400

» Free end bracket

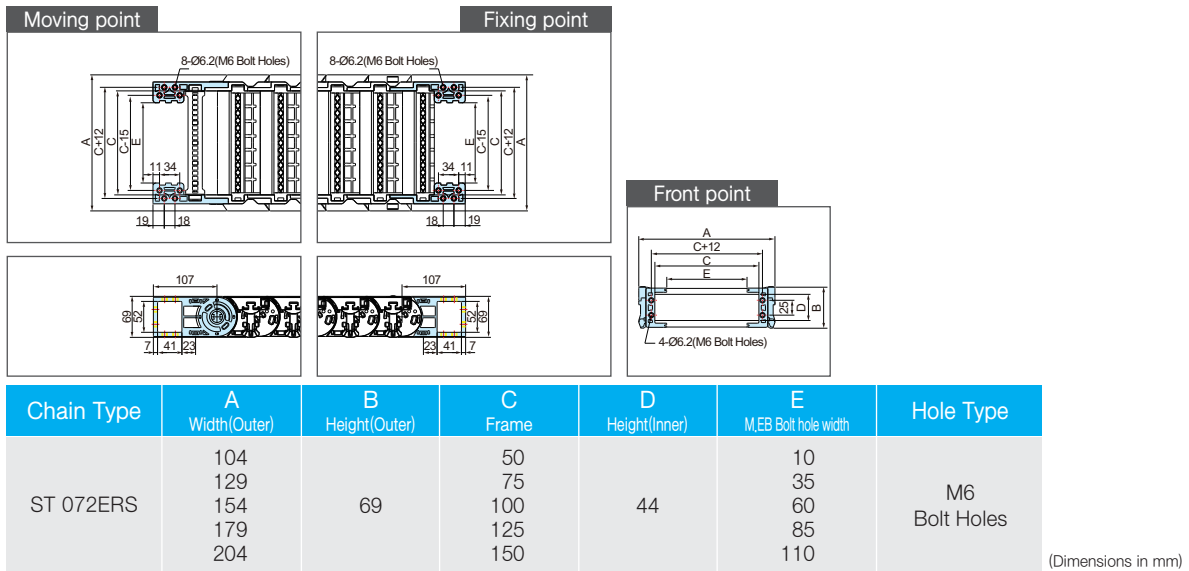

» System tie wrap (STW)

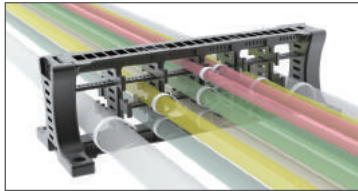

It is a unit to classify each cable for preventing entanglement of cables. It can either be installed to free end bracket or installed separately according its application environment.

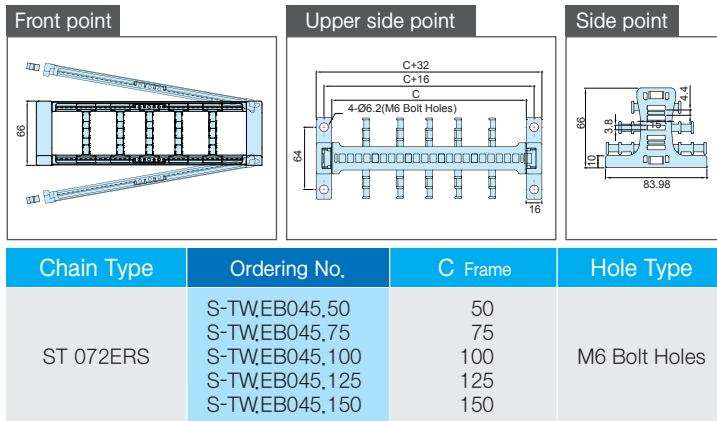

» Tie wrap (TW)

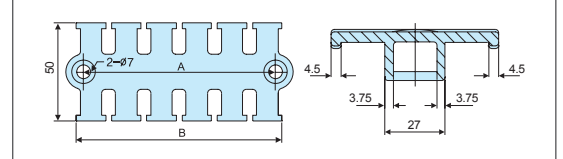
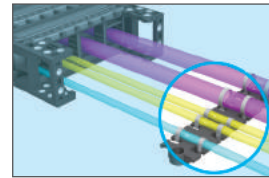

Chain Type	Ordering No.	A	B
ST 072ERS	S-TW50	58	65
	S-TW75	75	82
	S-TW100	98	105
	S-TW125	122	129
	S-TW150	141	148

(Dimensions in mm)

» Guide channel

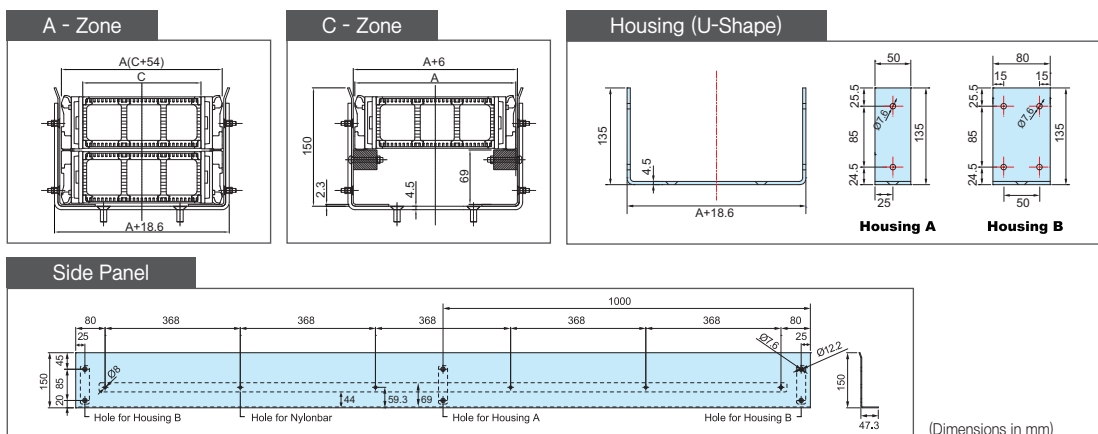

ST 095ERS

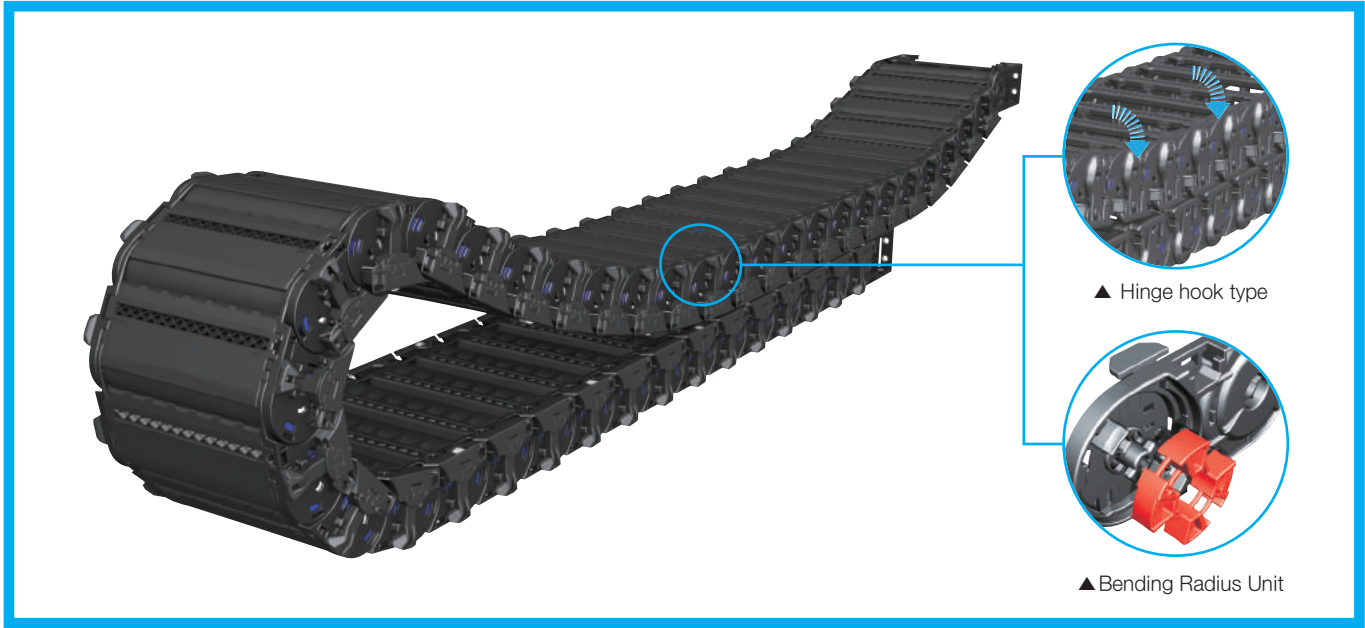

Layout of the chain

Ls: Stroke

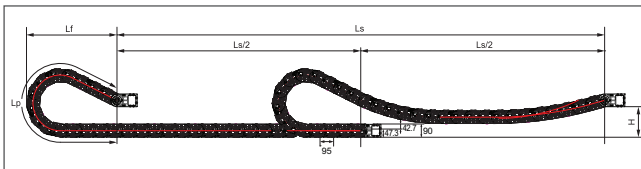

Bending Radius (R)	Lp Loop Length	Lf Loof Projection	H Moving Height
150	1,178	534	210
200	1,479	634	
230	1,666	694	
280	2,146	889	
400	3,232	1,319	

(Dimensions in mm)

Chain cross section

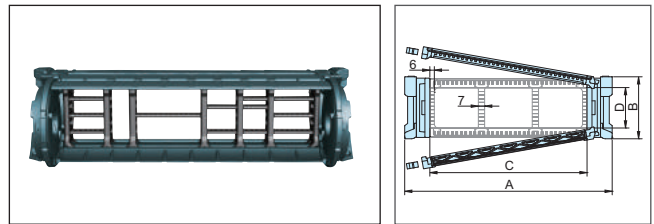

Chain Type	A Width(Outer)	B Height(Outer)	C Frame	D Height(Inner)	Weight kg/m
ST 095ERS	168	90	100	55	4.20
	193		125		4.45
	218		150		4.70
	243		175		4.95
	268		200		5.19

(Dimensions in mm)

Dividers(DV)

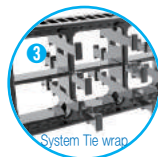
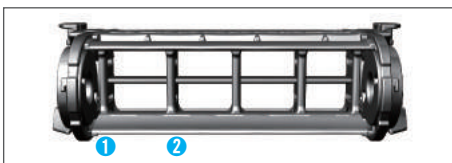

Assemble divider every second frame.
 DV.M : Normal Divider.
 DV.W : Applicable to System Tie Wrap or FEB.

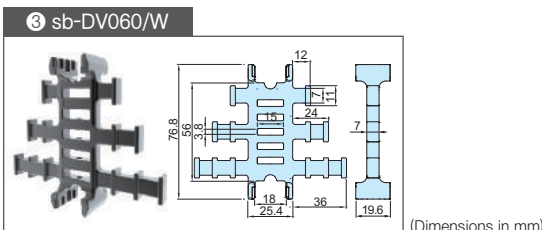
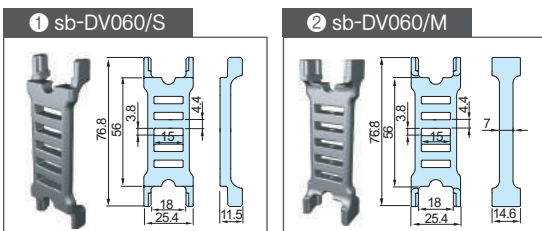

(Dimensions in mm)

Separators(SP)

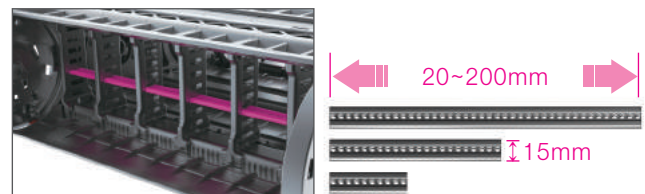

Chain Type	Ordering NO.
ST 095ERS	sb-SP/400,400

ST 120ERS

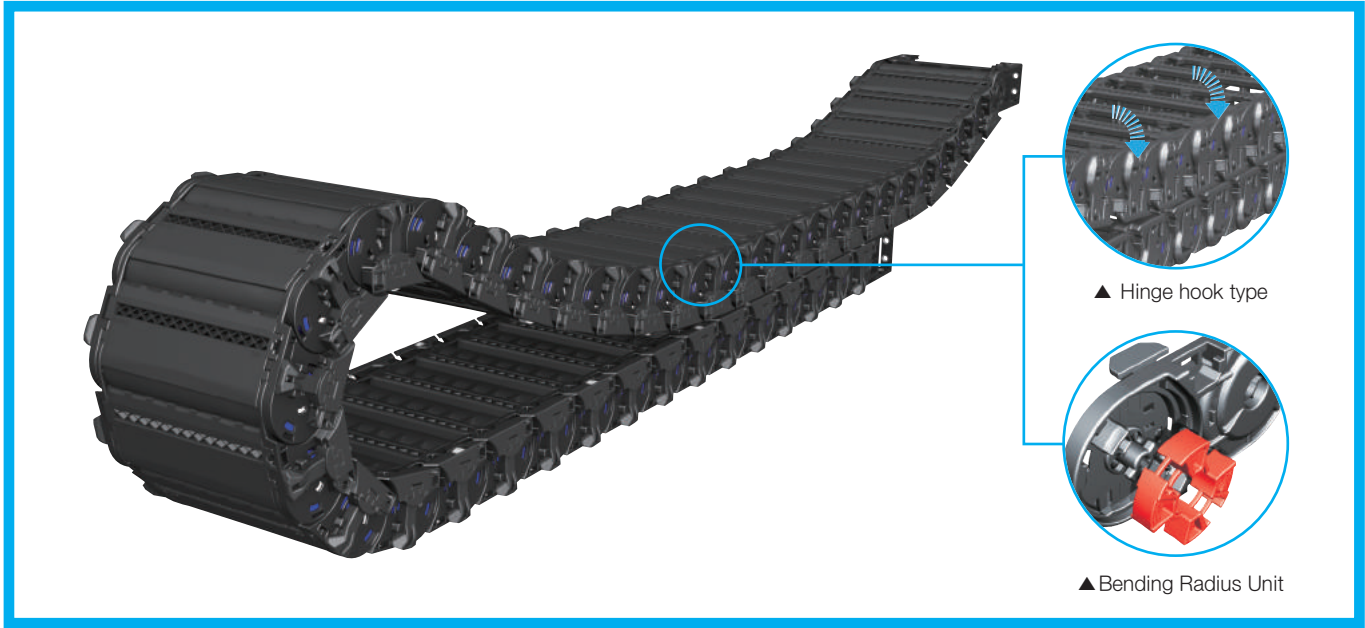

Layout of the chain

Ls: Stroke

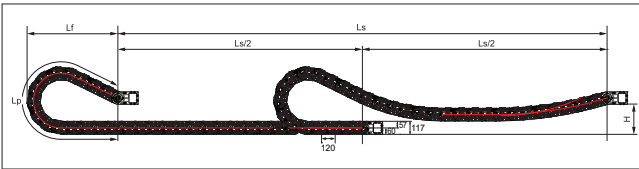

Bending Radius (R)	Lp Loop Length	Lf Loof Projection	H Moving Height
200	1,559	694	260
250	1,864	794	
300	2,178	894	
350	2,701	1,114	
400	3,225	1,334	
500	4,062	1,654	

(Dimensions in mm)

Chain cross section

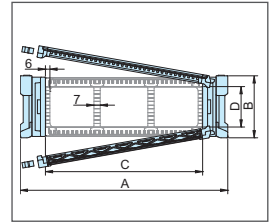
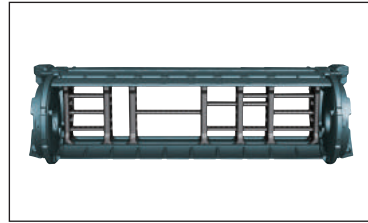

Chain Type	A Width(Outer)	B Height(Outer)	C Frame	D Height(Inner)	Weight kg/m
ST 120ERS	218	117	150	76	5.17
	268		200		5.48
	318		250		5.78
	368		300		6.09

(Dimensions in mm)

Dividers(DV)

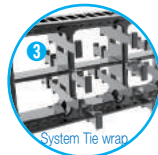
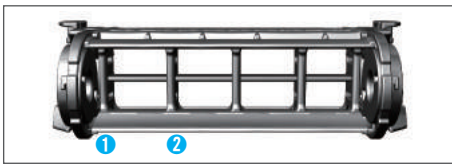

Assemble divider every second frame.
 DV.M : Normal Divider.
 DV.W : Applicable to System Tie Wrap or FEB.

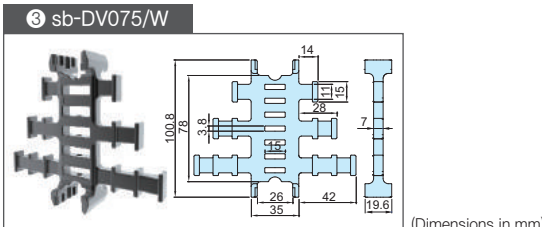
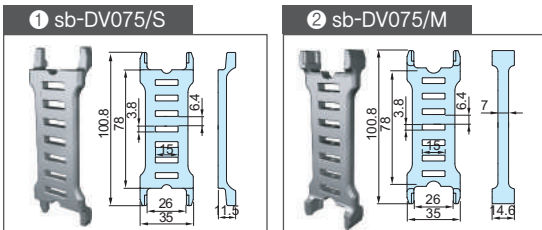

(Dimensions in mm)

Separators(SP)

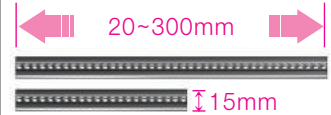
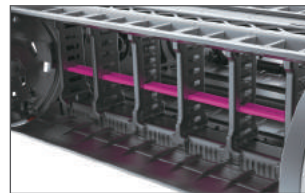

Chain Type	Ordering NO.
ST 120ERS	sb-SP/400,400

